

Common Fastener Types

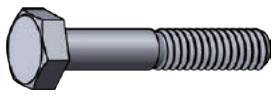

Hex bolts, or hex cap screws, are used in machinery and construction. Can be used with a nut, or in a tapped hole. Fully threaded hex bolts are also known as tap bolts.

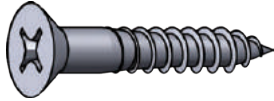

Wood screws have large threads and a smooth shank for pulling two pieces of material together. They can be used in wood and other soft materials.



Sheet metal screws have sharp points and threads, and are designed to be driven directly into sheet metal. They can also be used in softer materials like plastic, fiberglass, or wood.



Machine screws are fully threaded for use with a nut or in a tapped hole. Certain types are sometimes referred to as stove bolts.



Socket screws are machine screws with an internal hex socket (Allen) drive. Longer lengths may have a smooth shank.

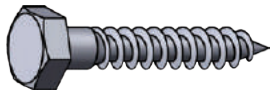

Lag bolts, or lag screws, are large wood screws with hex heads. Typically used for wood construction.

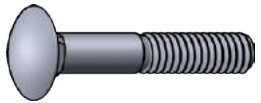

Carriage bolts have smooth, domed heads with a square section underneath that pulls into the material to prevent spinning during installation.

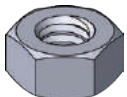

Nuts are used to fasten machine threaded fasteners in through-hole applications. Lock nuts help prevent loosening.

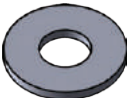

Washers spread the load over a greater surface area when tightening a bolt, screw or nut. Lock washers help prevent loosening.

Tip: Find a more comprehensive fastener type chart at www.mbs-standoffs.com

Grade/Class & Fastener Strength

Fastener Grade (US) or Class (metric) refers to the mechanical properties of the fastener material. Generally, a higher number indicates a stronger, more hardened (but also more brittle) fastener.

For a chart of fastener grades, head markings and mechanical properties, see Mbs Standoffs Grade markings and Strength Chart at www.mbs-standoffs.com

US bolt head markings



Low Carbon Grade 5 Grade 8

Metric bolt head markings



Class 8.8 Class 10.9 Class 12.9

Note: In addition to these markings, the head will often have a manufacturer stamp.

Fastener Materials

Note: Do not rely on this guide for color-matching. The appearance of these materials sometimes differs significantly from the photos below.

Zinc-plated steel is a low carbon steel for general use. Relatively inexpensive, with the zinc plating providing moderate corrosion resistance suitable for indoors or otherwise dry conditions. Color is either a blue-ish tint or yellow depending on the exact process.



Hot-dipped galvanized steel has a thicker zinc coating for better corrosion resistance, making it suitable for outdoor use. Because of the thick plating, only galvanized nuts and washers will fit galvanized bolts. The coating typically has a rough, dull grey finish.



Stainless steel offers good corrosion resistance, making it suitable for outdoor use and marine applications, but is more expensive than zinc plated.



Chrome and nickel plated steel are smooth and polished for appearance. The plating offers moderate corrosion resistance.



Brass and bronze are copper alloys with good corrosion resistance. More expensive than steel, these materials are typically used for decorative applications. Colors can vary significantly.



Alloy steel is highly hardened and usually black oxide and/or oil coated, offering little corrosion resistance.



How Fasteners are Notated: An Example



Machine screws, Phillips pan head, Stainless steel 18-8, #12-24 x 1"

Fastener type

Material

Diameter

Length

Thread Count (TPI)

Drive Types

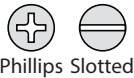

Phillips Slotted

Phillips and Slotted drives are common in screws, but prone to cam-out (stripping).



Combo

Combo drives, that can be used with either driver, are available for many fastener types.



Frearson Pozidriv

Frearson and Pozidriv are similar to Phillips, but less prone to cam-out.



Hex socket (Allen)

Hex socket (Allen) drives are compact and easy to drive, but prone to cam-out.



Star Square (Robertson)

Star and Square drive are resistant to cam-out and can be installed single-handed.

Note: Most drive types (Frearson and Slotted being notable exceptions) require the correct driver size for proper installation.

Head Styles



Hex heads are typically used with larger bolts and screws, and tightened with a wrench.



Pan heads have a slightly domed head that sits above the surface.



Flat heads are installed in a countersunk hole for a flat surface.



Round heads are tall domed heads, used primarily for decorative purposes.



Oval heads are a low domed and countersunk heads, used primarily for decorative purposes.



Truss heads are slightly domed, with a wide head for an extra large surface area.



Socket heads are narrow with a socket drive, and knurled or smooth sides.



Button heads feature a medium dome. Typically used with a hex socket drive.

Measuring Diameter

For most types of fasteners, the diameter is measured on the outside of the threads.

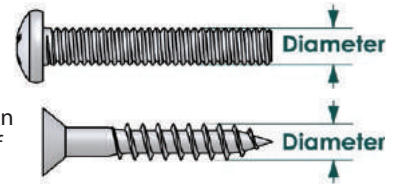

Note: US diameters under 1/4" are given as numbers (e.g. #12) instead of inches, in order of increasing size. If you need to find the actual diameter, use a table corresponding to your fastener type at www.mbs-standoffs.com

Thread Count & Thread Pitch

Machine threaded fasteners specify a thread density in Threads Per Inch (US) or as a Thread Pitch in mm (Metric).

For a given diameter, a fastener may be available in coarse (standard), fine and sometimes super fine thread.

Measuring Length

Fastener length is usually measured from where the material is assumed to be to the end of the fastener.

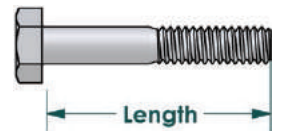

Thus, countersunk fasteners are measured overall and non-counter-sunk fasteners are measured from under the head.

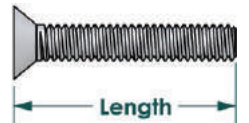

Nut & Washer Sizes

Nut and washer sizes indicate the screw or bolt they fit. For example:

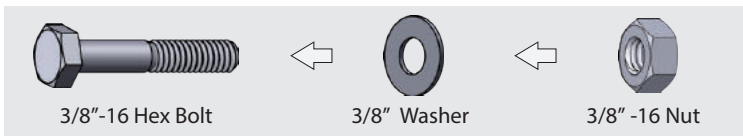

Different washer patterns have different outside diameters. For example, hardened US washers are available in USS (wider) and SAE (narrower) patterns. Fender washers have large outside diameters.

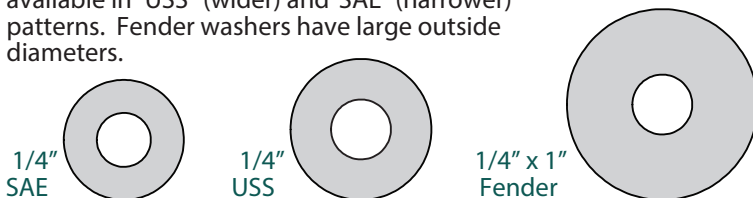

More Information

At www.mbs-standoffs.com you'll find:

- In-depth fastener info
- Charts and tables
- Printable lay-over charts and tools for quickly identifying fastener sizes and types
- Much more...



Fastener Categories

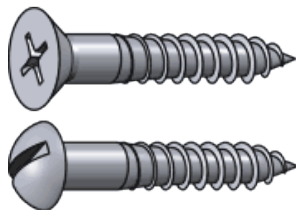

Wood Screws

Screws with a smooth shank and tapered point for use in wood. Abbreviated WS.

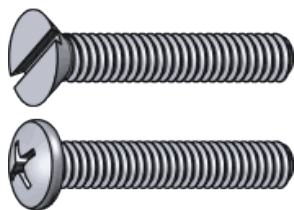

Machine Screws

Screws with threads for use with a nut or tapped hole. Abbreviated MS.

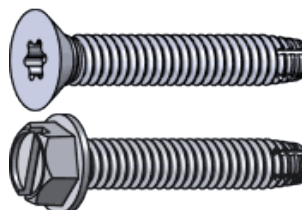

Thread Cutting Machine Screws

Machine screws with a thread cutting (self tapping) point.

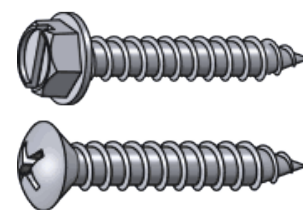

Sheet Metal Screws

Fully threaded screws with a point for use in sheet metal. Abbreviated SMS.

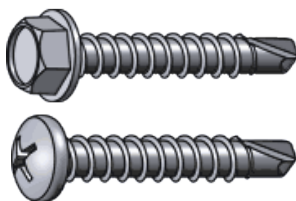

Self Drilling SMS

A sheet metal screw with a self drilling point.

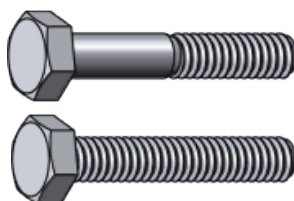

Hex Bolts

Bolts with a hexagonal head with threads for use with a nut or tapped hole. Abbreviated HHMB or HXBT.



Carriage Bolts

Bolts with a smooth rounded head that has a small square section underneath.

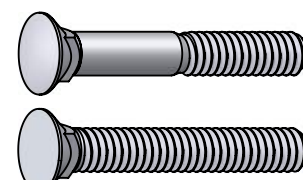

Plow Bolts

Similar to carriage bolts but used for attaching the cutting edge of a plow to the plow blade.

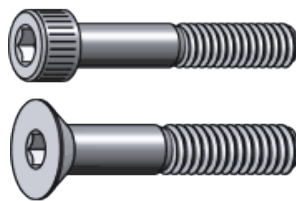

Socket Screws

Socket screws, also known as Allen Head, are fastened with a hex Allen wrench.

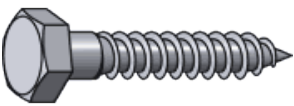

Lag Bolts

Bolts with a wood thread and pointed tip. Abbreviated Lag.



Eye Bolts

A bolt with a circular ring on the head end. Used for attaching a rope or chain.



Eye Lags

Similar to an eye bolt but with wood threads instead of machine thread.



J-Bolts

J shaped bolts are used for tie-downs or as an open eye bolt.

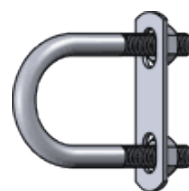

U-Bolts

Bolts in U shape for attaching to pipe or other round surfaces. Also available with a square bend.



Shoulder Bolts

Shoulder bolts (also known as stripper bolts) are used to create a pivot point.



Elevator Bolts

Elevator bolts are often used in conveyor systems. They have a large, flat head.

Fastener Categories (continued)

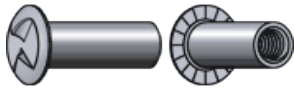

Sex Bolts

Sex bolts (a.k.a. barrel nuts or Chicago bolts) have a female thread and are used for through bolting applications where a head is desired on both sides of the joint.

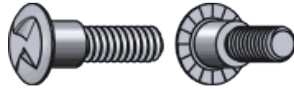

Mating Screws

Mating screws have a shoulder that matches the diameter of the sex bolts they are used with.



Hanger Bolts

Hanger bolts have wood thread on one end and machine thread on the other end.



Set Screws

Machine screws with no head for screwing all the way into threaded holes.



Timber Bolts

Machine threaded fasteners with a wide domed head. The head has fins underneath that prevent the bolt from spinning during installation. Typically used in wood.



Cotter Pins

Cotter or split pins have two tines which are bent apart to hold them in place.



Rivets

Used to join sheets of metal. During installation the rivet body is deformed to permanently lock in place. Blind rivets can be installed without access to the back side of the material.

Head Styles

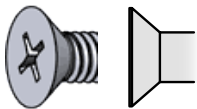

Flat

A countersunk head with a flat top.
Abbreviated FH

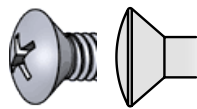

Oval

A countersunk head with a rounded top.
Abbreviated OH or OV

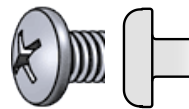

Pan

A slightly rounded head with short vertical sides.
Abbreviated PN

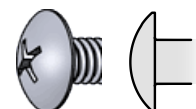

Truss

An extra wide head with a rounded top.

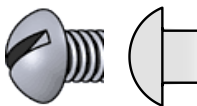

Round

A domed head.
Abbreviated RH

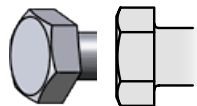

Hex

A hexagonal head
Abbreviated HH or HX

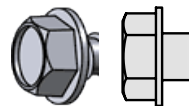

Hex Washer

A hex head with built in washer.



Hex Flange

A hex head with built in flange.



Slotted Hex Washer

A hex head with built in washer and a slot.

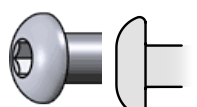

Button

A low-profile rounded head using a socket drive.

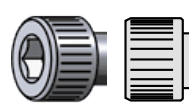

Socket Cap

A small cylindrical head using a socket drive.

Drive Types

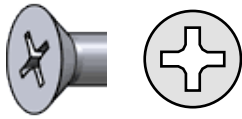

Phillips and Frearson

An X-shaped drive.
Abbreviated PH.

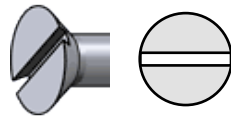

Slotted

A slot in the head.
Abbreviated SL.

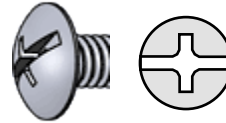

Combination

A combination of slotted and
Phillips drives.
Abbreviated combo.

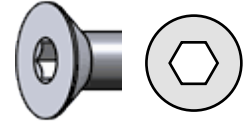

Socket, Hex or Allen

A hexagonal hole for use
with an Allen wrench.

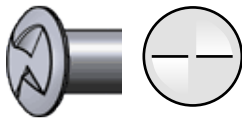

One Way

Installs with a normal slotted
driver but can not be
removed without special
tools.

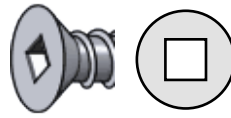

Square

Also known as Robertson
drive.
Abbreviated SQ or SD.

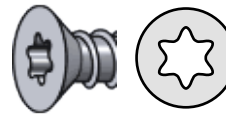

Star

A six-pointed star pattern,
specifically designed to
prevent cam-out and stripped
heads.

Washer Types

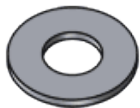

Flat

A flat washer, used to
distribute load. Available in
SAE, USS and other patterns.

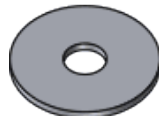

Fender

An oversize flat washer used
to further distribute load
especially on soft materials.



Finishing

A washer used to obtain a
'finished' look. Usually used
with oval head screws.



Split Lock

The most common style of
washer used to prevent nuts
and bolts from backing out.



External Tooth Lock

A washer with external
'teeth'. Used to prevent nuts
and bolts from backing out.



Internal Tooth Lock

A washer with internal 'teeth'.
Used to prevent nuts and
bolts from backing out.

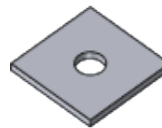

Square

A square shaped washer.

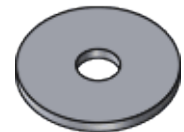

Dock

Dock washers have a larger
outside diameter and are
thicker than standard.



Ogee

Thick, large diameter, cast
iron washers with a curved or
sculpted appearance.
Typically used in dock and
wood construction.

Nut Types

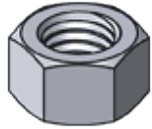

Hex

A six sided nut. Also referred to as a Finished Hex Nut.

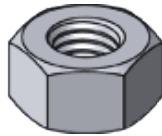

Heavy Hex

A heavier pattern version of a standard hex nut.

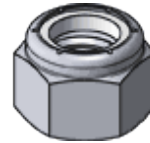

Nylon Insert Lock

A nut with a nylon insert to prevent backing off. Also referred to as a Nylock.

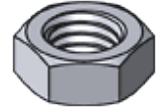

Jam

A hex nut with a reduced height.



Nylon Insert Jam Lock

A nylock nut with a reduced height.



Wing

A nut with 'wings' for hand tightening.

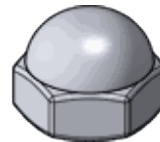

Cap

A nut with a domed top over the end of the fastener.



Acorn

Acorn nuts are a high crown type of cap nut, used for appearance.

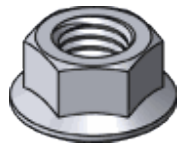

Flange

A nut with a built in washer like flange.

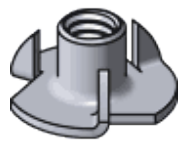

Tee

A nut designed to be driven into wood to create a threaded hole.

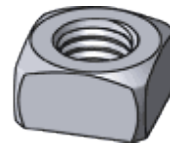

Square

A four sided nut.

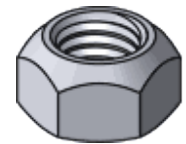

Prevailing Torque Lock

A non-reversible lock nut used for high temperature applications.

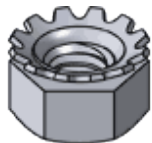

K-Lock or Kep

A nut with an attached free-spinning external tooth lock washer.



Coupling

Coupling nuts are long nuts used to connect pieces of threaded rod or other male fasteners.

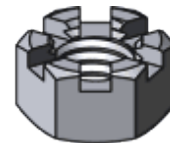

Slotted

Slotted nuts are used in conjunction with a cotter pin on drilled shank fasteners to prevent loosening.

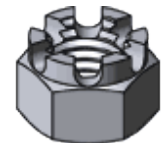

Castle

Castle nuts are used in conjunction with a cotter pin on drilled shank fasteners to prevent loosening.



Pin Lock

A nut that does not require an high installation torque and can be installed and removed without thread damage.

Anchoring Products



Stud Anchors

A.k.a. Wedge Anchors. One piece expansion bolts for heavy duty fastening into stone or solid concrete.

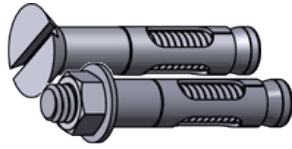

Sleeve Anchors

Heavy duty masonry anchors. Does not require a solid base material for installation.



Lag Shields

Medium duty anchors for use in concrete, brick or mortar. Use with a lag bolt.

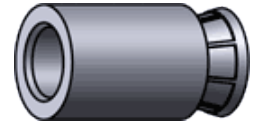

Machine Screw Anchors

A two-piece machine thread anchor for use in stone, brick, or concrete.



Drop-in Anchors

A heavy duty machine thread anchor for concrete or stone.

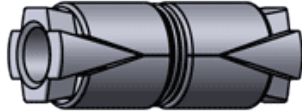

Double Expansion Sleeves

Expansion anchor for masonry that ensures contact along the length of the hole.

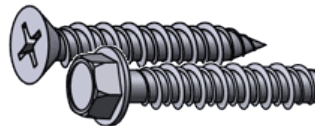

Concrete Screws

Used in concrete, brick or block. A quick and easy way to fasten in light to medium duty applications



Spring Toggle Wings

Non-removable fasteners that expand behind the material, e.g. inside a wall, for a secure grip.



Plastic Toggle

When these anchors are driven in they expand inside the hole for a secure grip. Drill hole the same size as the anchor. Non-removable.

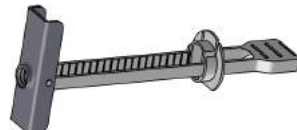

Kaptoggle®

A non removable anchor commonly used for hollow spaces such as drywall and masonry block.

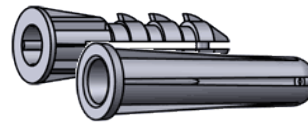

Conical Anchors

Plastic anchors used with sheet metal screws. Can be used in most materials.

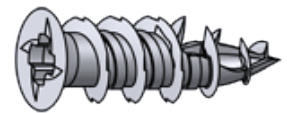

Self Drilling Drywall Anchors

Quick-install plastic anchors used in drywall with sheet metal screws.

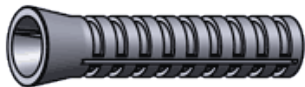

Wood Screw Anchors

This anchor is made of lead and can be used with wood screws or sheet metal screws.

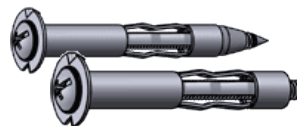

Hollow Wall Anchors

A.k.a. Molly Bolts. Used for light duty anchoring in drywall or other hollow walls.

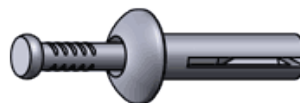

Nail Drive Anchors

Non removable anchors that expand inside the hole when the nail like pin is driven.



Anchor Bolts

L shaped, machine threaded anchors. Typically embedded in concrete when it is poured.



Mbs-Standoffs.com
fastener shopping made easy

**US and Metric
Ruler**

For more printable tools and charts, see
www.mbs-standoffs.com



cut or fold

IMPORTANT: Make sure to print this chart to **Actual Size** (no scaling).

After printing, check the ruler (e.g. against the short side of a letter size paper - 8 1/2 in - or another ruler) to ensure correct scale. See www.mbs-standoffs.com for more details.

US Thread Sizes

Metric Thread Pitches

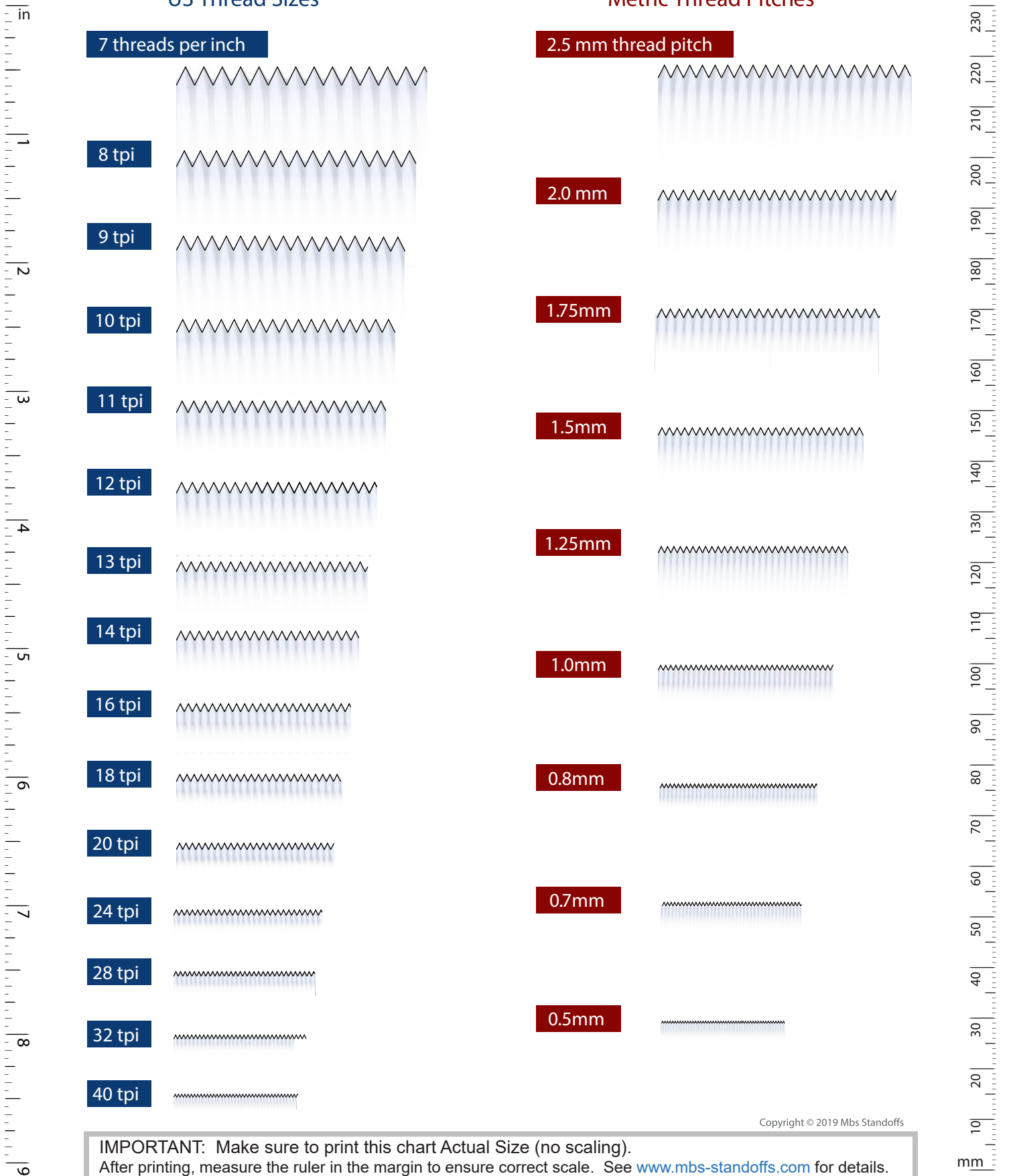

IMPORTANT: Make sure to print this chart Actual Size (no scaling).
After printing, measure the ruler in the margin to ensure correct scale. See www.mbs-standoffs.com for details.



Length is measured from under the head to the end of the bolt

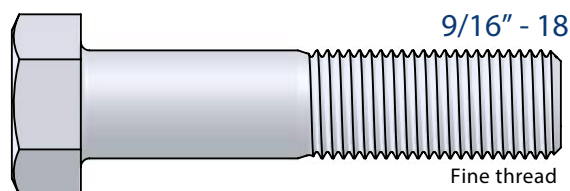
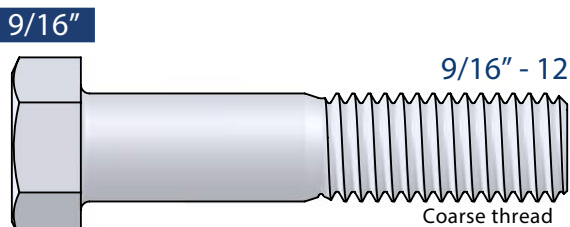
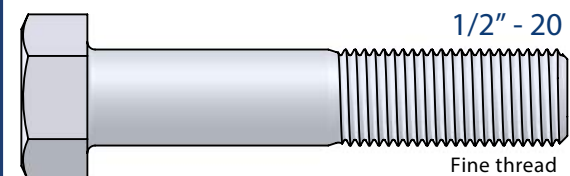
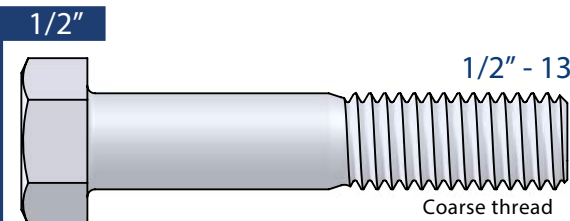
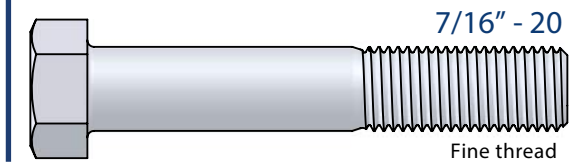
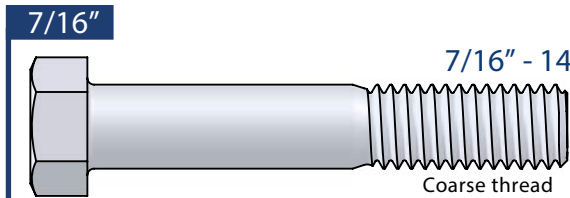
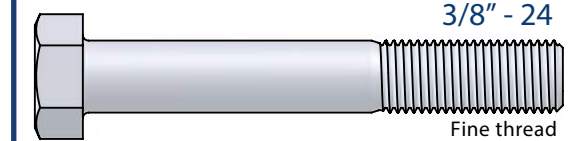
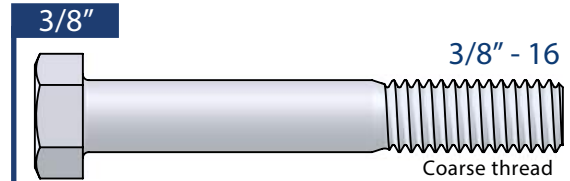
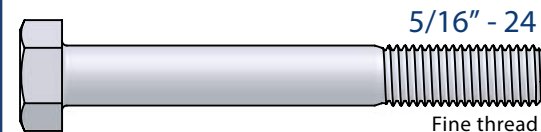
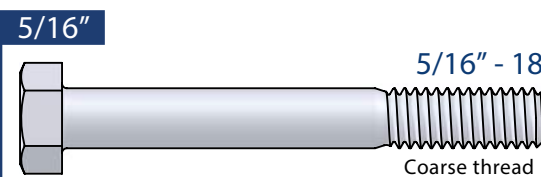
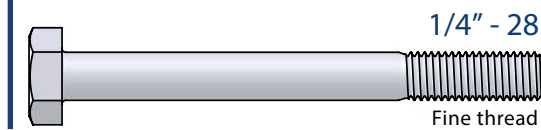
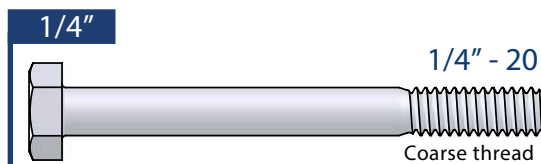
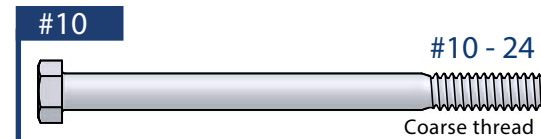
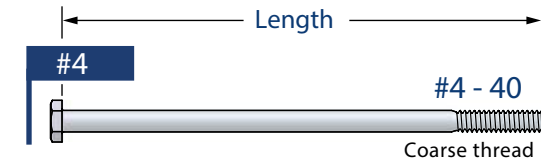

IMPORTANT: Make sure to print this chart to Actual Size (no scaling).
After printing, measure the ruler in the margin to ensure correct scale. See www.mbs-standoffs.com for more details.

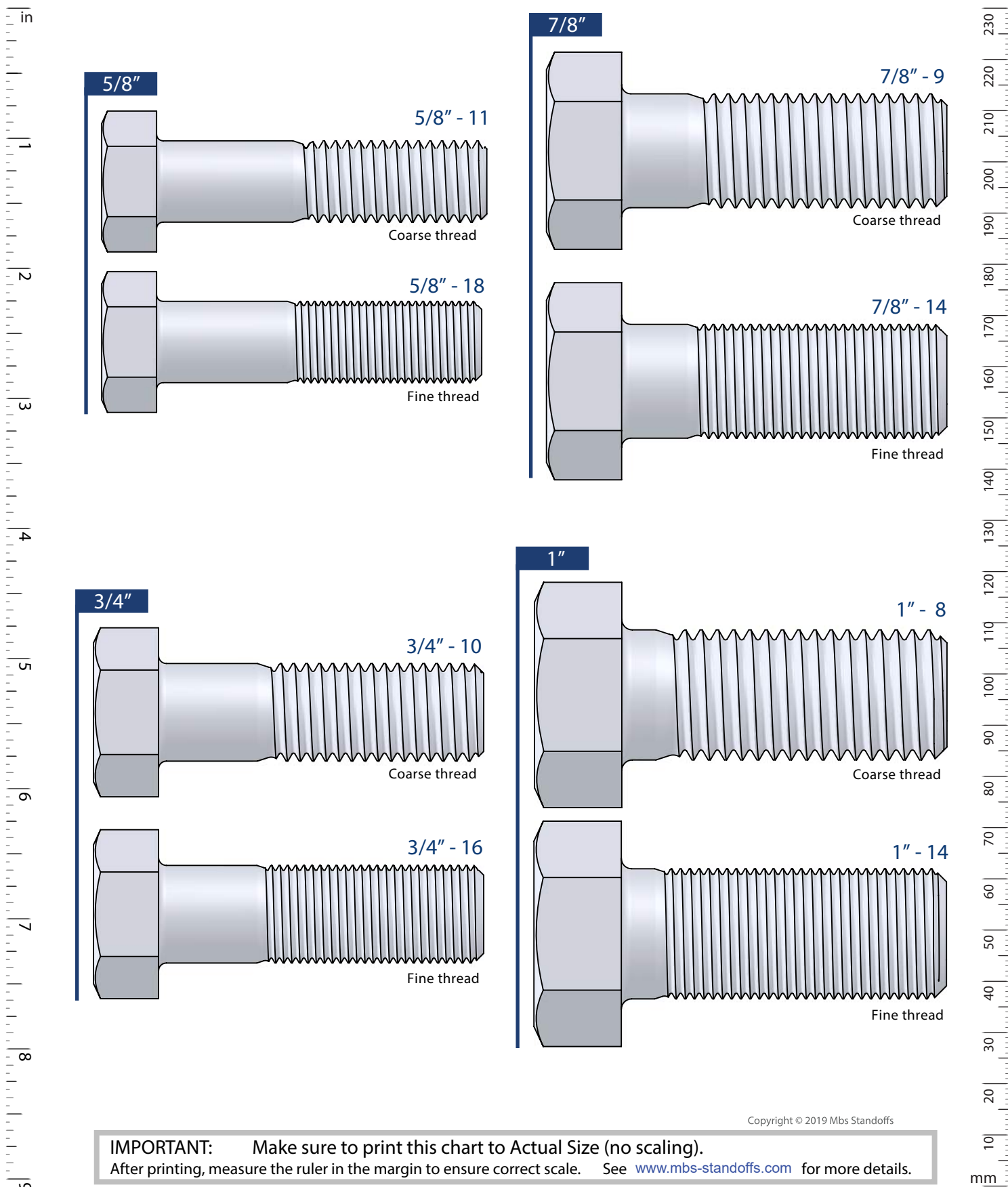

IMPORTANT: Make sure to print this chart to Actual Size (no scaling).
After printing, measure the ruler in the margin to ensure correct scale. See www.mbs-standoffs.com for more details.

Length is measured from where the surface is assumed to be, to the end of the screw. Therefore, pan head screws are measured from under the head, and flat head screws are measured overall.

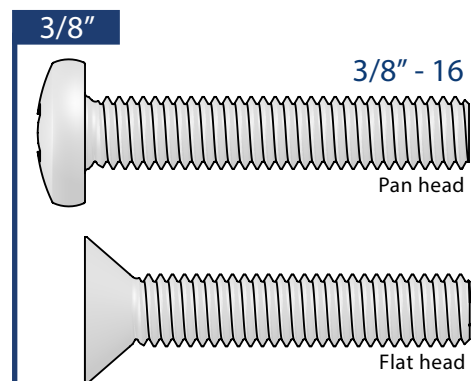
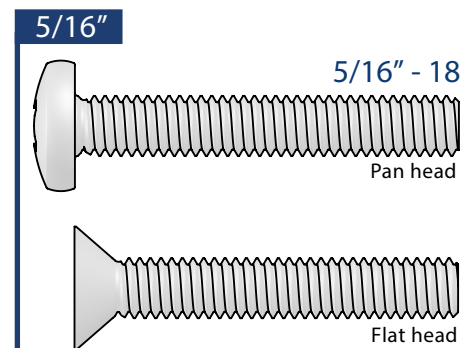
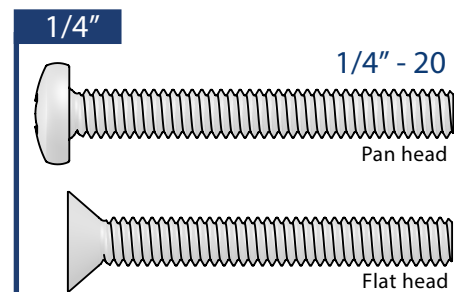
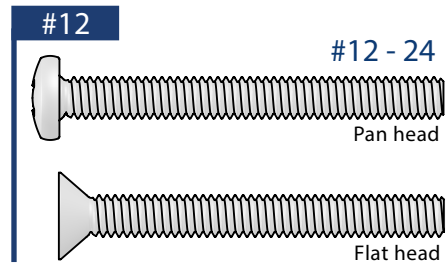
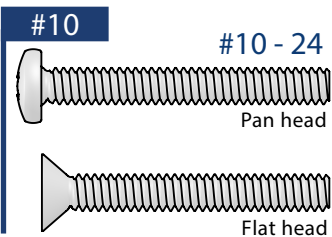
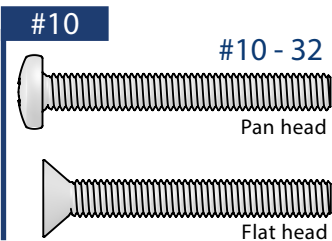
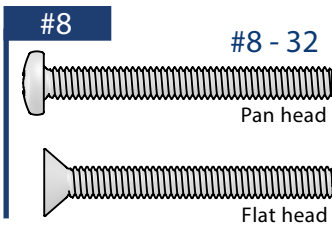
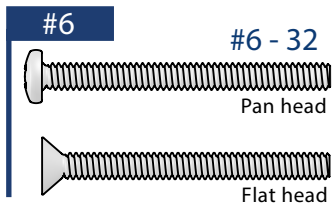
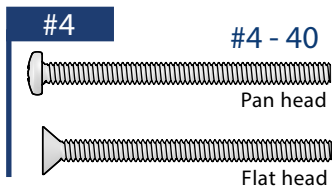
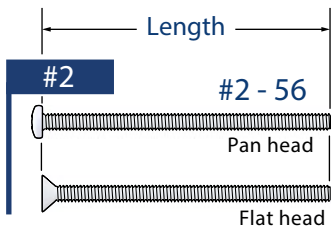

IMPORTANT: Make sure to print this chart to Actual Size (no scaling).
After printing, measure the ruler in the margin to ensure correct scale. See www.mbs-standoffs.com for more details.

Fastener length is measured from where the material surface is assumed to be, to the end of the fastener.

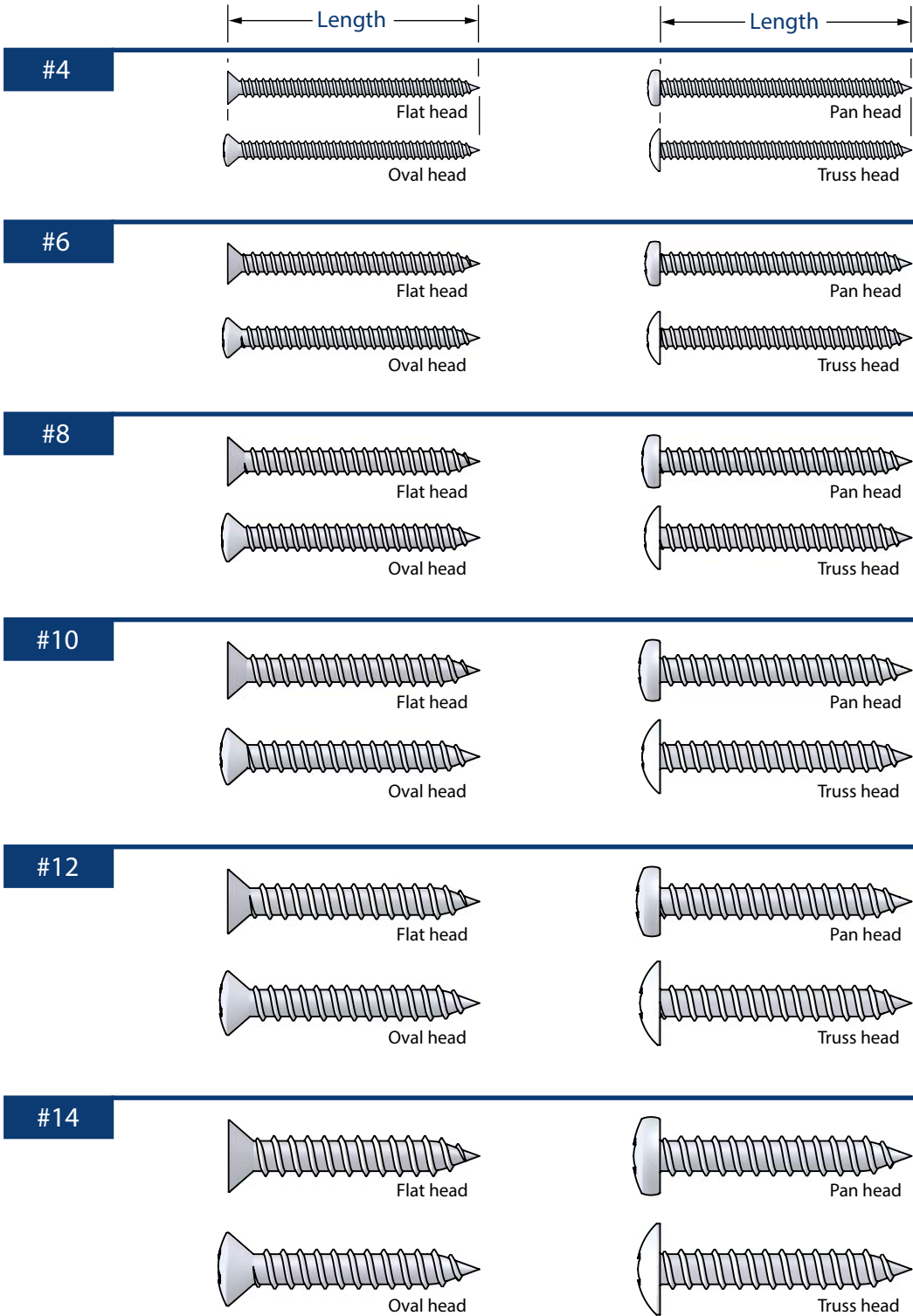
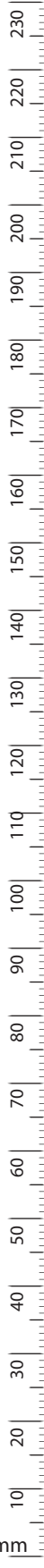

IMPORTANT: Make sure to print this chart to Actual Size (no scaling).
After printing, measure the ruler in the margin to ensure correct scale. See www.mbs-standoffs.com for more details.

| | | Hex | Jam | Nylock | Jam nylock | |
|--|-------------------------------|-----|-----|--------|---------------|-----|
| | #0 5/32" wrench | | | N/A | N/A | N/A |
| | #1 5/32" wrench | | | N/A | N/A | N/A |
| | #2 3/16" wrench | | | N/A | N/A | N/A |
| | #3 3/16" wrench | | | N/A | N/A | N/A |
| | #4 1/4" wrench | | | N/A | | N/A |
| | #5 5/16" wrench | | | N/A | N/A | N/A |
| | #6 5/16" wrench | | | N/A | | N/A |
| | #8 11/32" wrench | | | N/A | | N/A |
| | #10 3/8" wrench | | | N/A | | |
| | #12 7/16" wrench | | | N/A | | N/A |
| | 1/4" 7/16" wrench | | | | | |
| | 5/16" 1/2" wrench | | | | | |
| | 3/8" 9/16" wrench | | | | | |
| | 7/16" 11/16" wrench | | | | | |

Note: Hex nuts with a diameter under 1/4" are called hex machine screw nuts



IMPORTANT: Make sure to print this chart to Actual Size (no scaling). After printing, measure the ruler in the margin to ensure correct scale. See www.mbs-standoffs.com for more details.



Hex

Jam

Nylock

Jam
nylock

1/2"

3/4" wrench

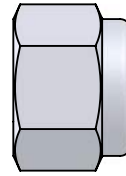
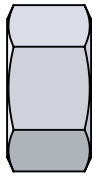
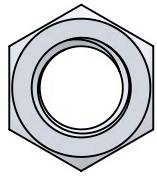

5/8"

15/16" wrench

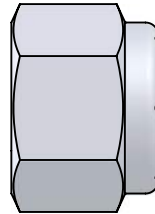
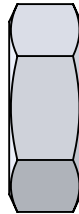
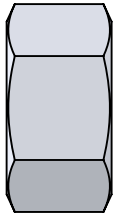
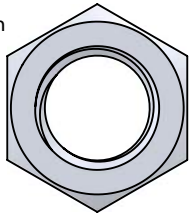

3/4"

1-1/8" wrench

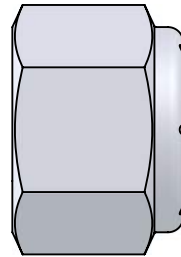
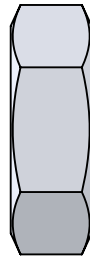
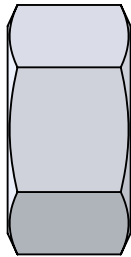
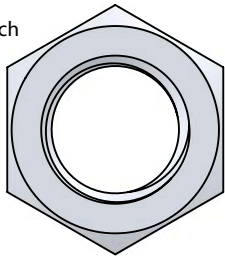

7/8"

1-5/16" wrench

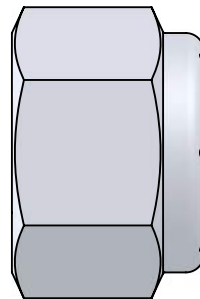
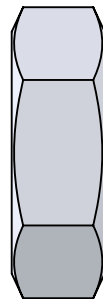
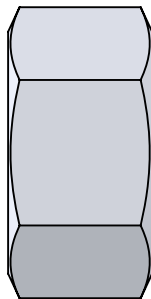
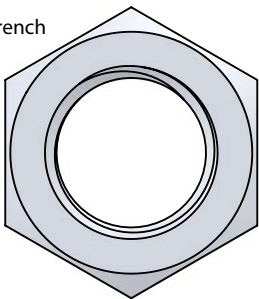

1"

1-1/2" wrench

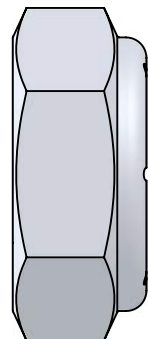
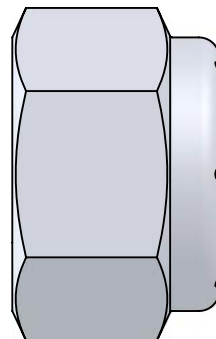
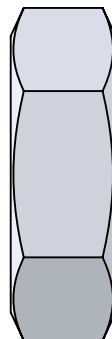
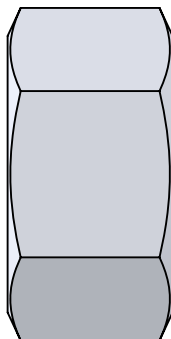
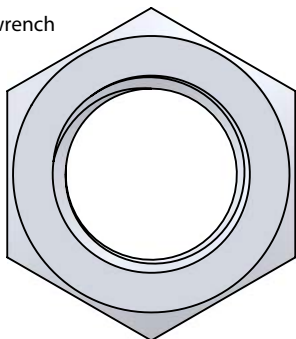

Copyright © 2019 Mbs Standoffs

IMPORTANT: Make sure to print this chart to Actual Size (no scaling). After printing, measure the ruler in the margin to ensure correct scale. See www.mbs-standoffs.com for more details.

mm

Washer sizes correspond to the screw/bolt diameter they fit. For example, a 1/2" washer fits a 1/2" bolt, and therefore has an inner diameter of just over 1/2".

#10

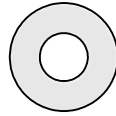

1/4"

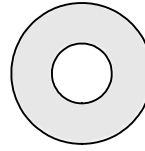

5/16"

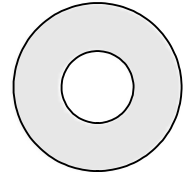

3/8"

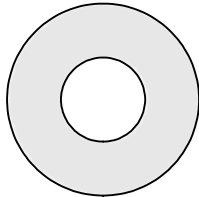

7/16"

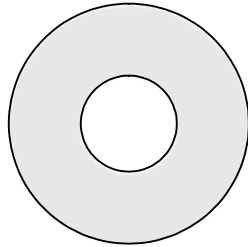

1/2"

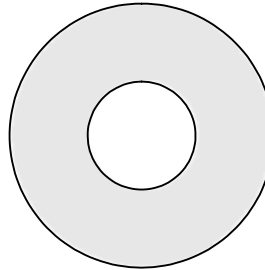

9/16"

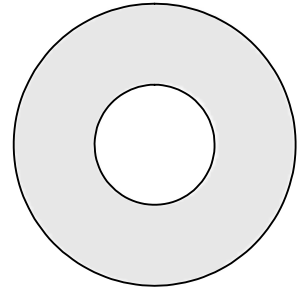

5/8"

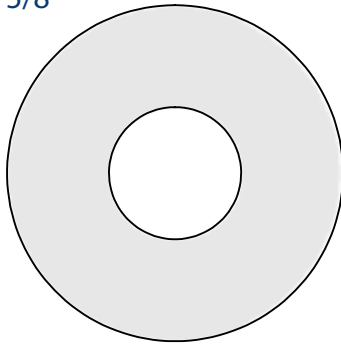

3/4"

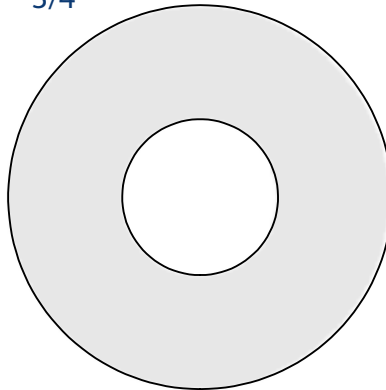

7/8"

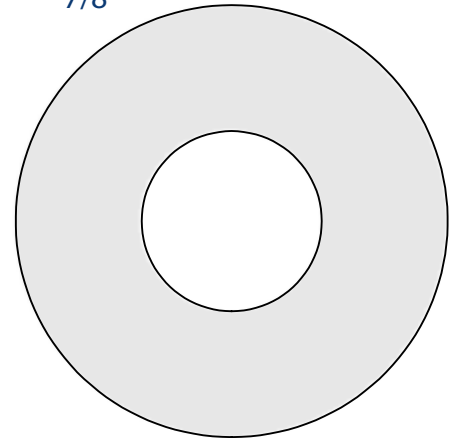

Large USS Washer Sizes

| Size | Diameter | |
|--------|----------|---------|
| | Inside | Outside |
| 1-1/8" | 1-1/4" | 2-3/4" |
| 1-1/4" | 1-3/8" | 3" |
| 1-3/8" | 1-1/2" | 3-1/4" |
| 1-1/2" | 1-5/8" | 3-1/2" |
| 1-5/8" | 1-3/4" | 3-3/4" |
| 1-3/4" | 1-7/8" | 4" |
| 2" | 2-1/8" | 4-1/2" |

1"

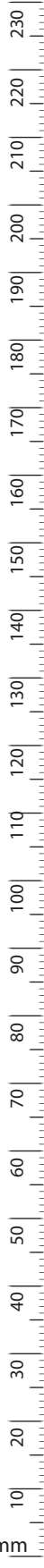
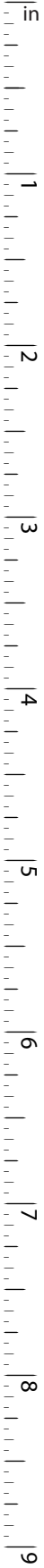
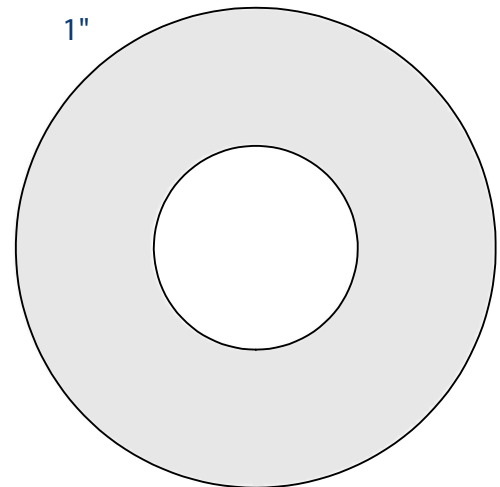

SAE Flat Washer Sizes

www.mbs-standoffs.com

Washer sizes correspond to the screw/bolt diameter they fit. For example, an 1/4" washer fits an 1/4" bolt, and therefore has an inner diameter of just over 1/4".

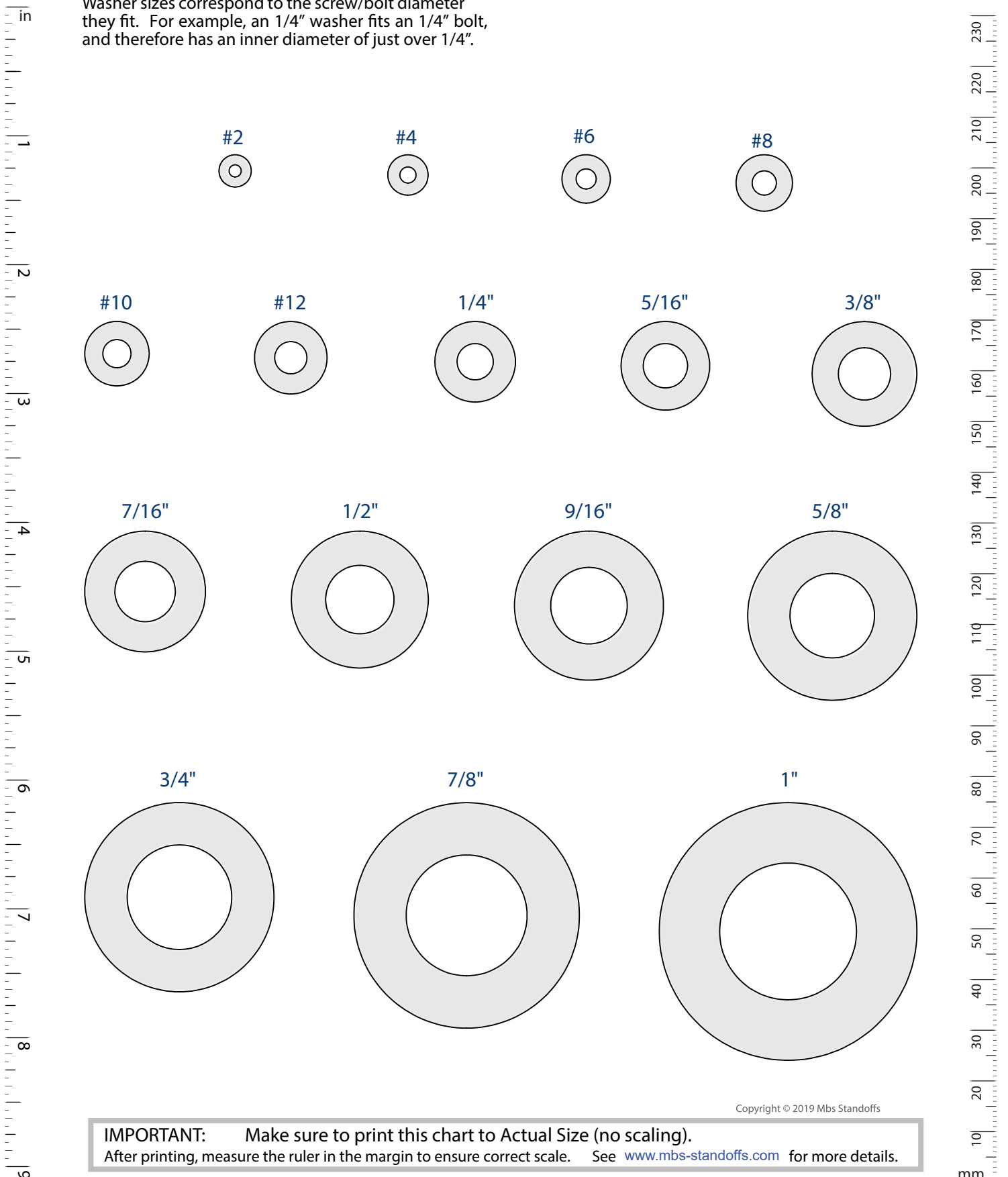

IMPORTANT: Make sure to print this chart to Actual Size (no scaling).
After printing, measure the ruler in the margin to ensure correct scale. See www.mbs-standoffs.com for more details.

Copyright © 2019 Mbs Standoffs

US Socket Cap Sizes

www.mbs-standoffs.com

Fastener length is measured from where the material surface is assumed to be, to the end of the fastener.

Length

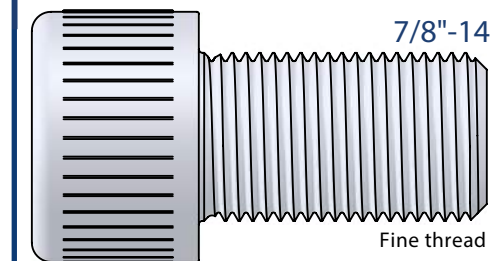
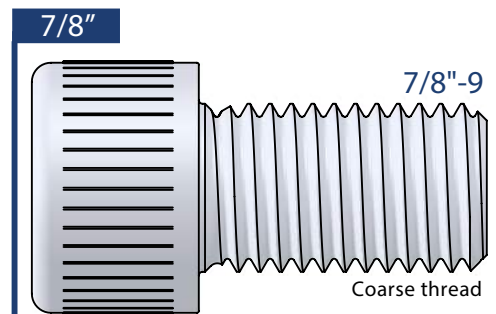
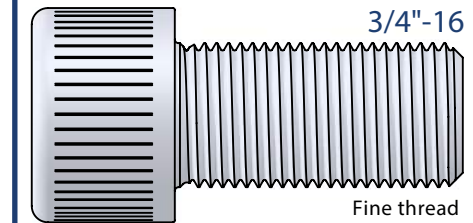
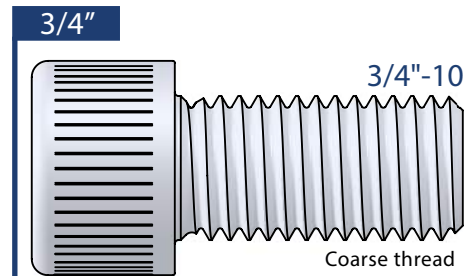
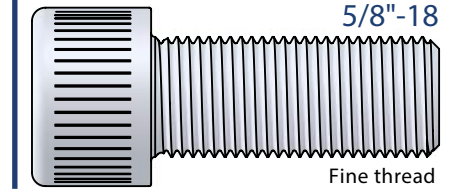
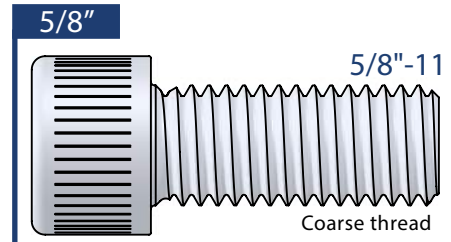
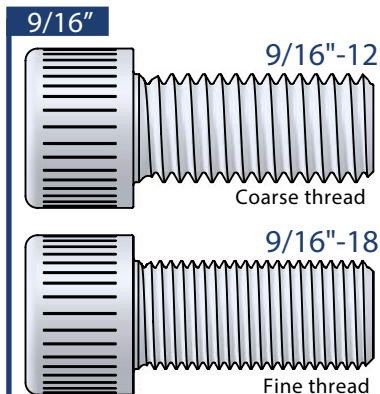
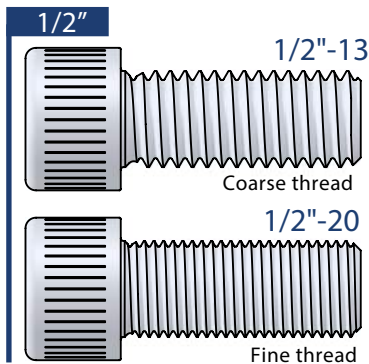
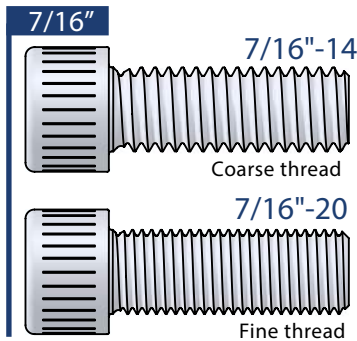
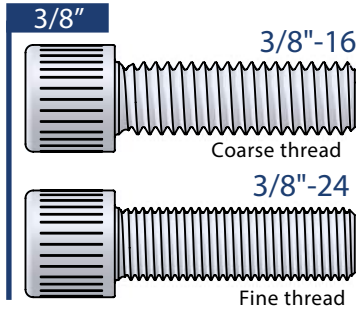
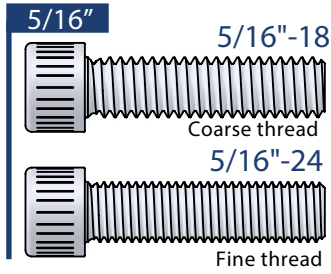
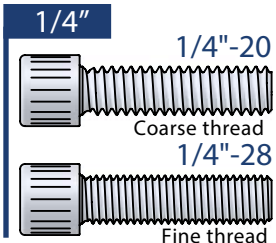
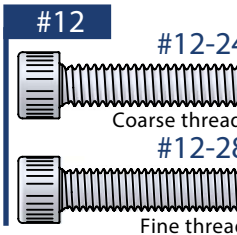
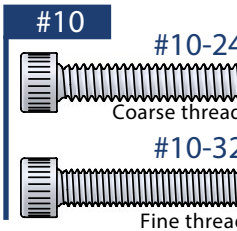
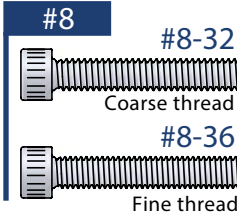
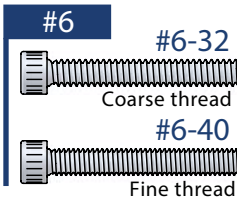
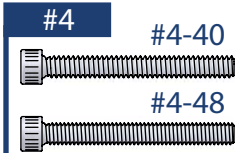
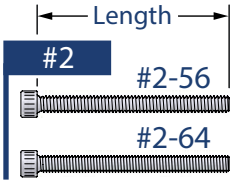
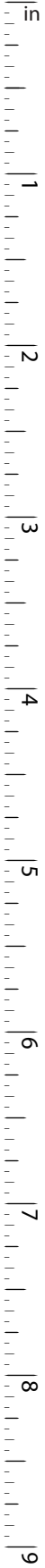

IMPORTANT: Make sure to print this chart to Actual Size (no scaling).
After printing, measure the ruler in the margin to ensure correct scale. See www.mbs-standoffs.com for more details.

Copyright © 2019 Mbs Standoffs

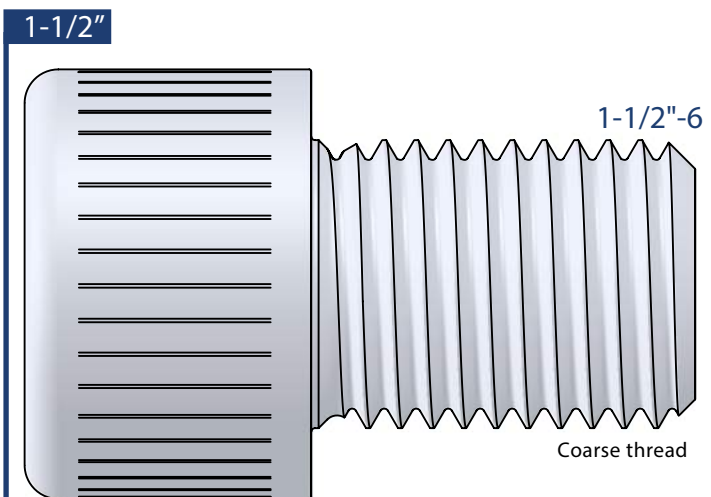
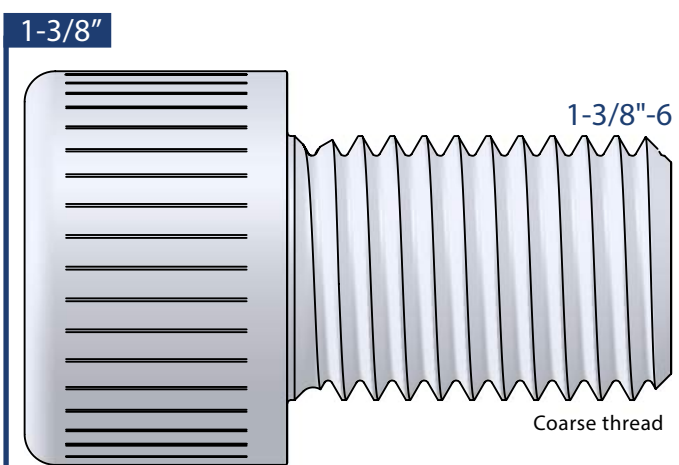
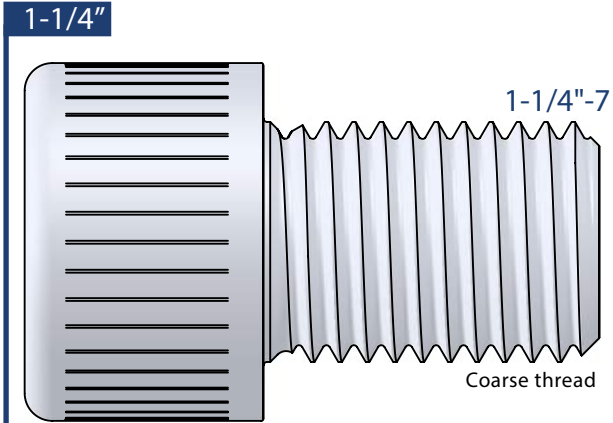
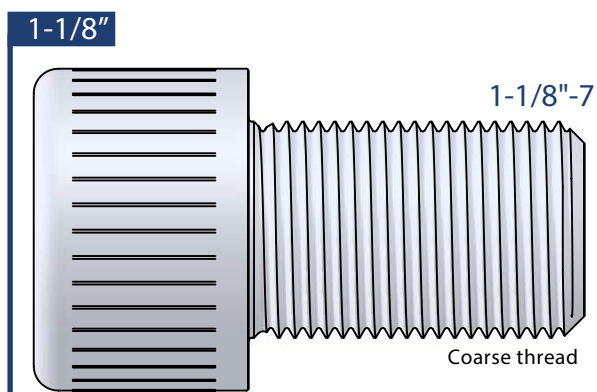
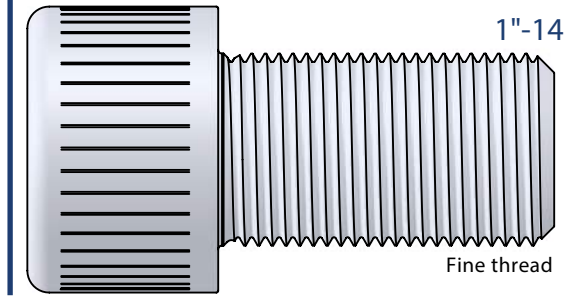
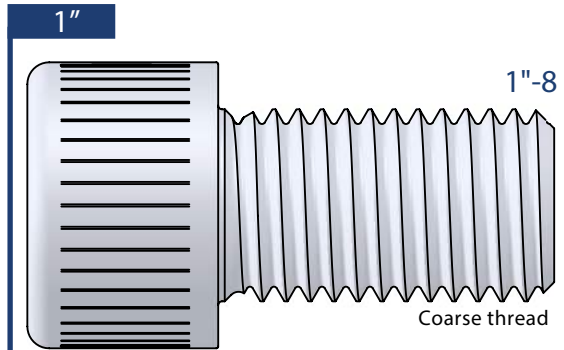
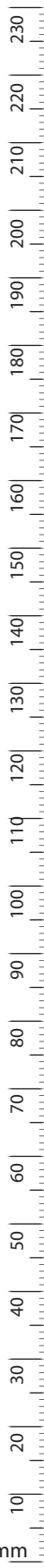
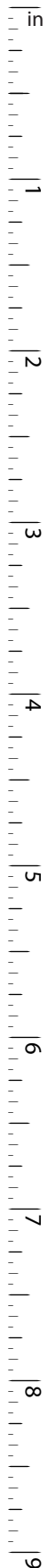

IMPORTANT: Make sure to print this chart to Actual Size (no scaling).
After printing, measure the ruler in the margin to ensure correct scale. See www.mbs-standoffs.com for more details.

US Socket Flat Head Sizes

www.mbs-standoffs.com

Fastener length is measured from where the material surface is assumed to be, to the end of the fastener.

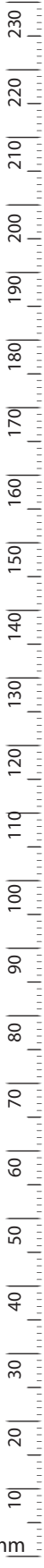
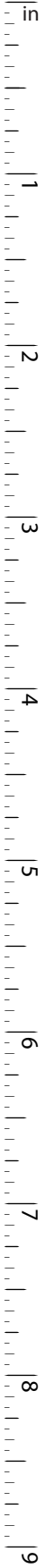
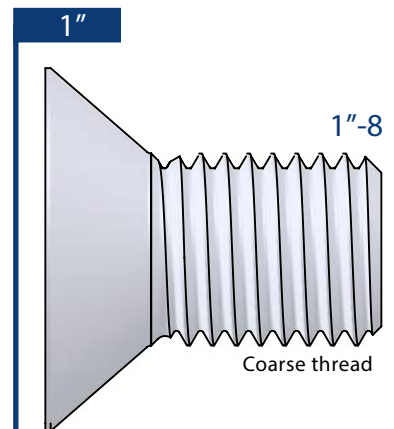
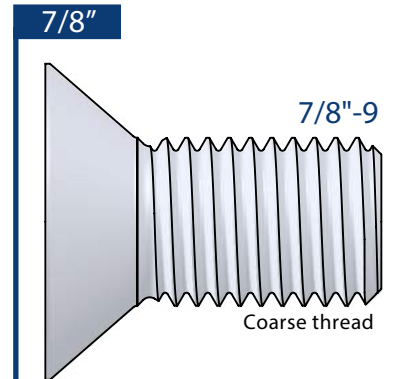
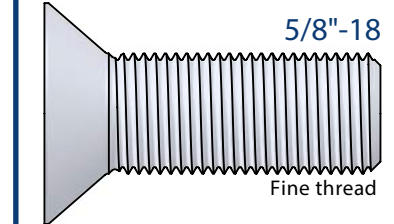
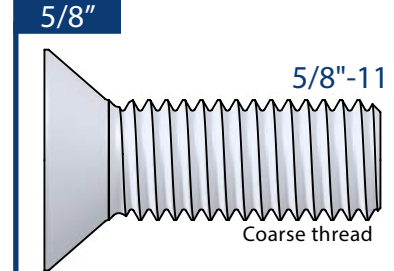
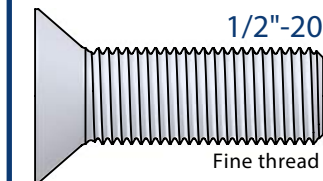
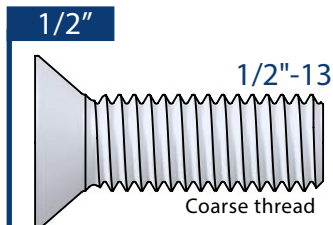
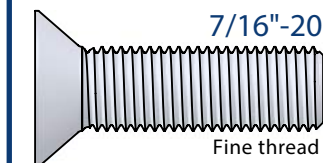
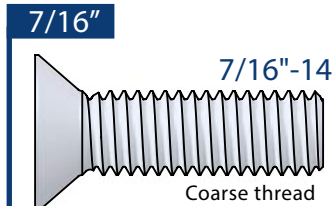
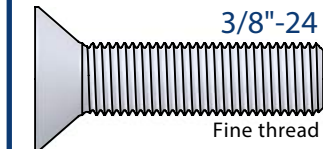
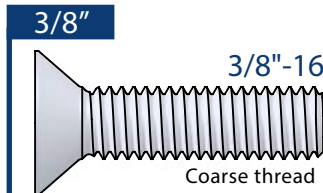
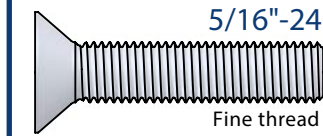
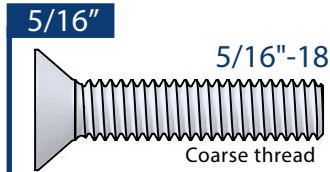
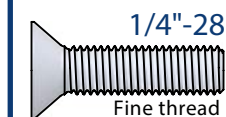
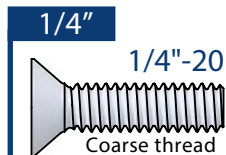
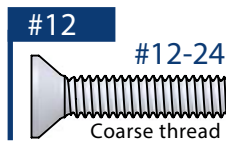
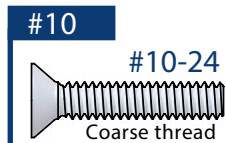
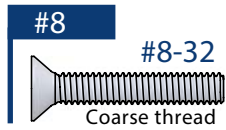
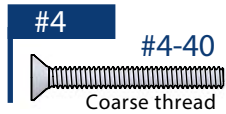
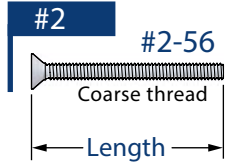

Copyright © 2019 Mbs Standoffs

IMPORTANT: Make sure to print this chart to Actual Size (no scaling).
After printing, measure the ruler in the margin to ensure correct scale. See www.mbs-standoffs.com for more details.

mm

US Socket Button Head Sizes

Fastener length is measured from where the material surface is assumed to be, to the end of the fastener.

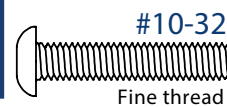
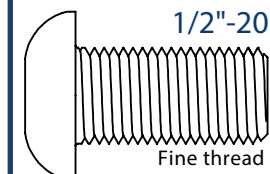
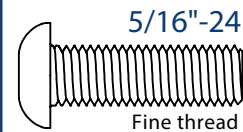
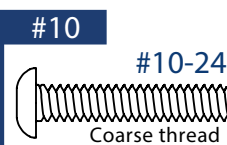
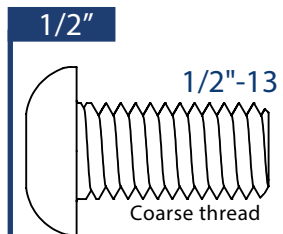
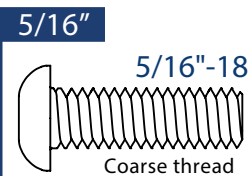
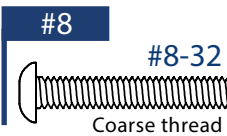
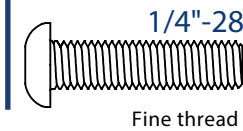
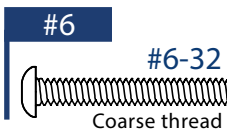
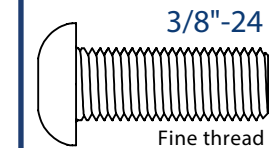
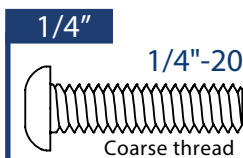
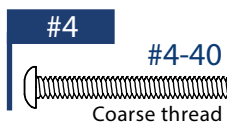
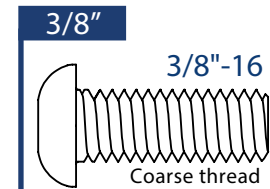
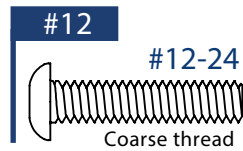
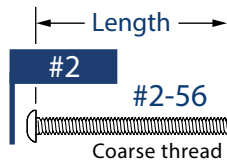
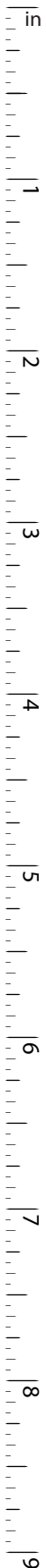

IMPORTANT: Make sure to print this chart to Actual Size (no scaling).
After printing, measure the ruler in the margin to ensure correct scale. See www.mbs-standoffs.com for more details.

Shoulder bolt size is determined by the diameter and length of the shoulder.

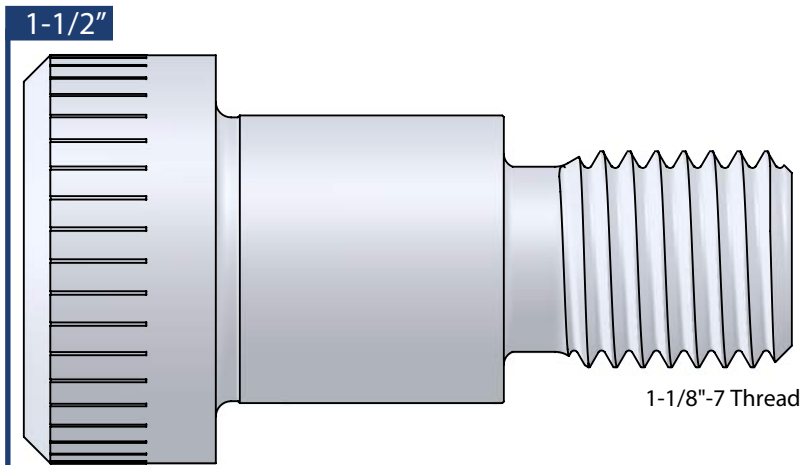
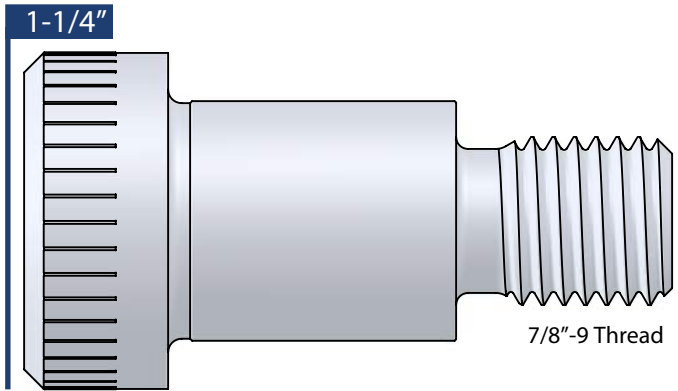
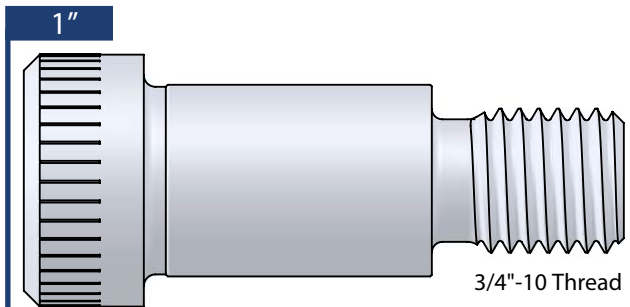
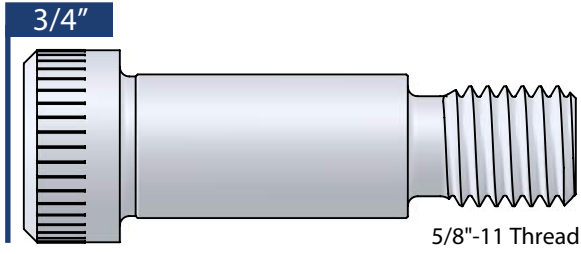
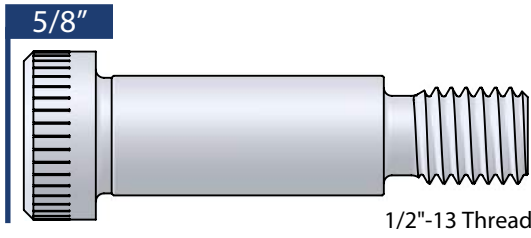
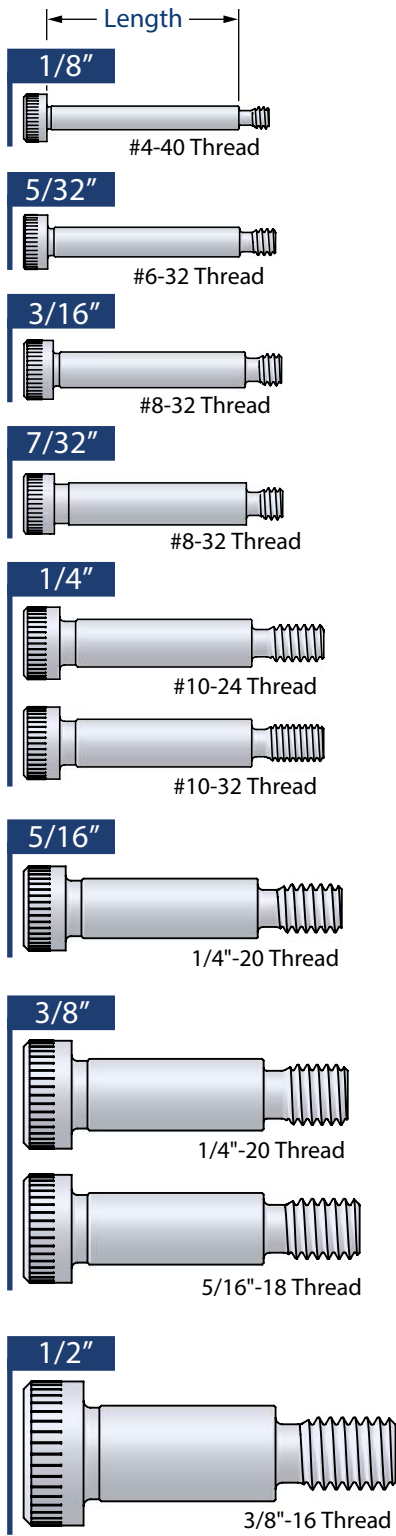
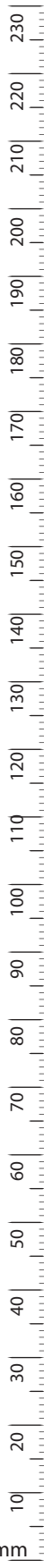

IMPORTANT: Make sure to print this chart to Actual Size (no scaling). After printing, measure the ruler in the margin to ensure correct scale. See www.mbs-standoffs.com for more details.

Screw eyes are sold by industry trade sizes (e.g. 112), which correspond to a specific wire diameter, inside eye diameter and length.

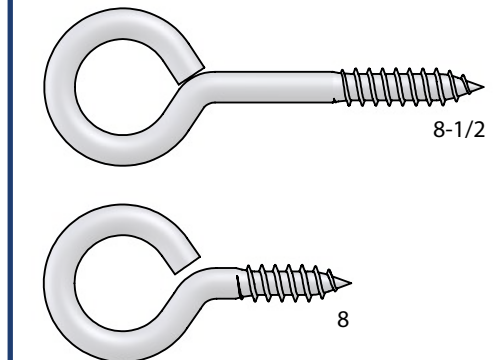
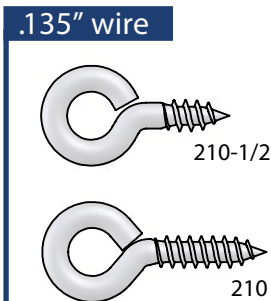
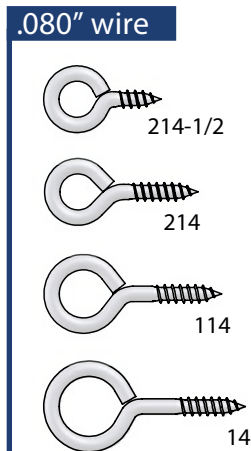
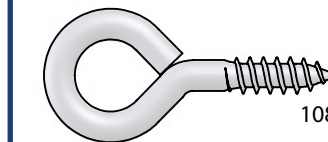
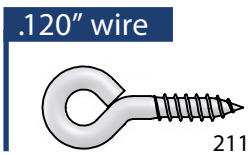
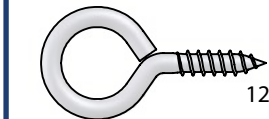
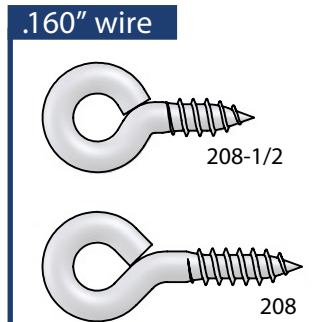
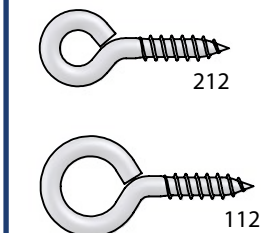
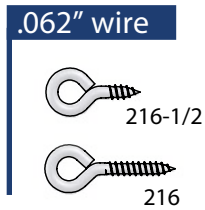
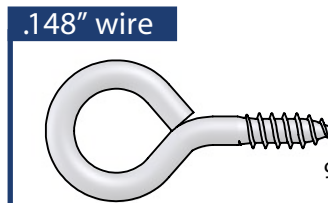
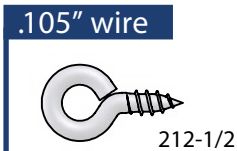
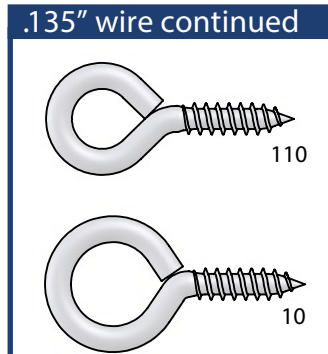
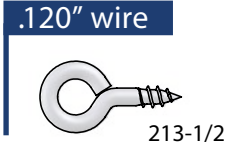
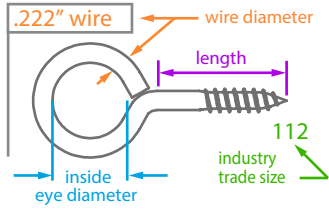

IMPORTANT: Make sure to print this chart to Actual Size (no scaling).
After printing, measure the ruler in the margin to ensure correct scale. See www.mbs-standoffs.com for more details.

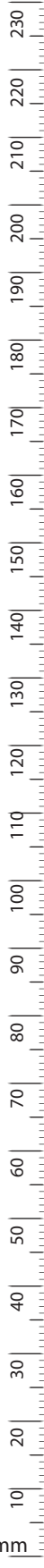
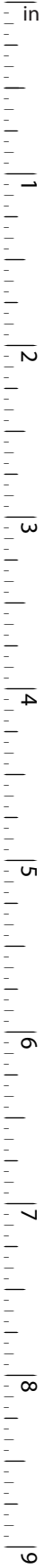

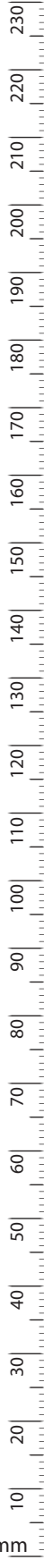
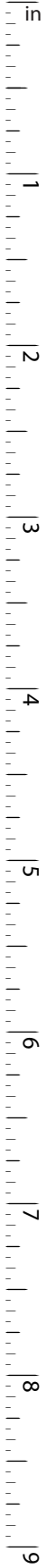

.192" wire

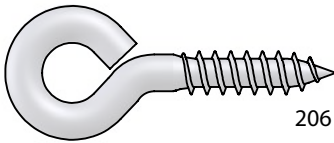
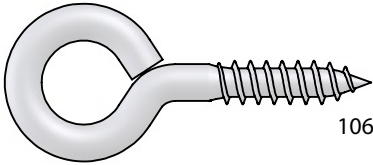
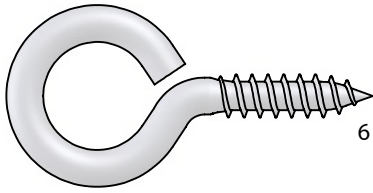

.264" wire

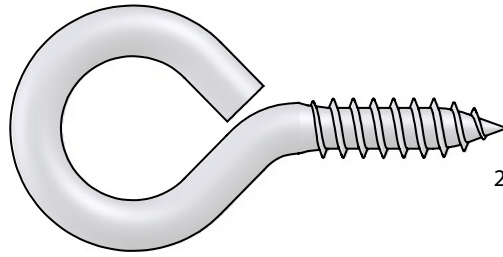

.307" wire

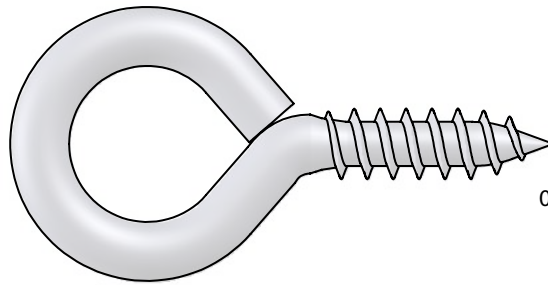

.225" wire

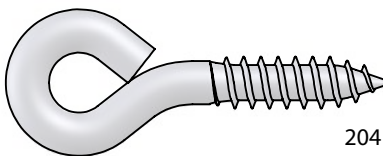
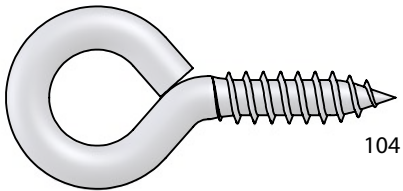
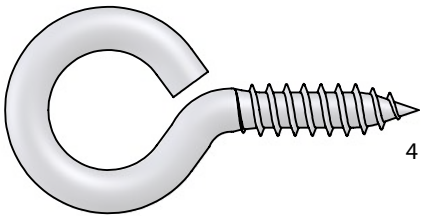

.331" wire

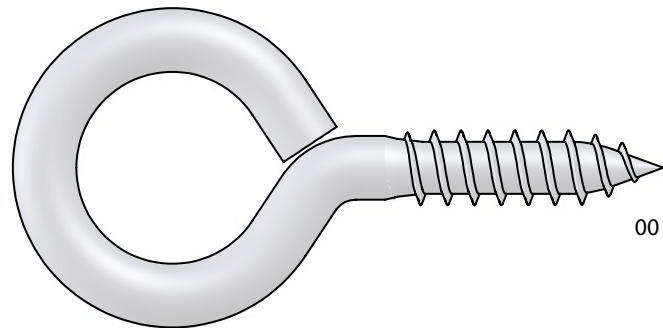

.365" wire

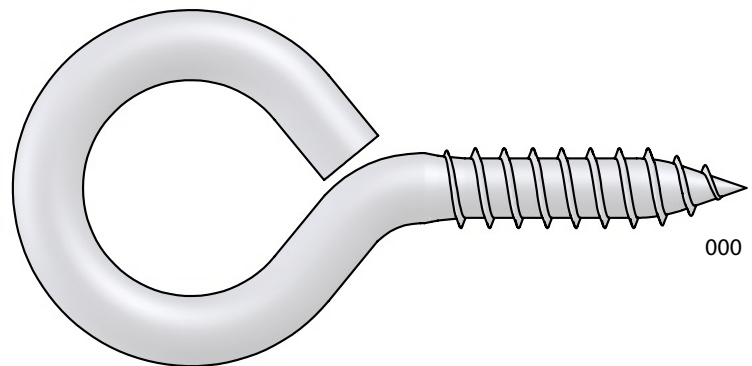

IMPORTANT: Make sure to print this chart to Actual Size (no scaling).
After printing, measure the ruler in the margin to ensure correct scale. See www.mbs-standoffs.com for more details.

Length is measured from under the head to the end of the bolt

Note: Head sizes may differ from what is shown due to differences between metric standards

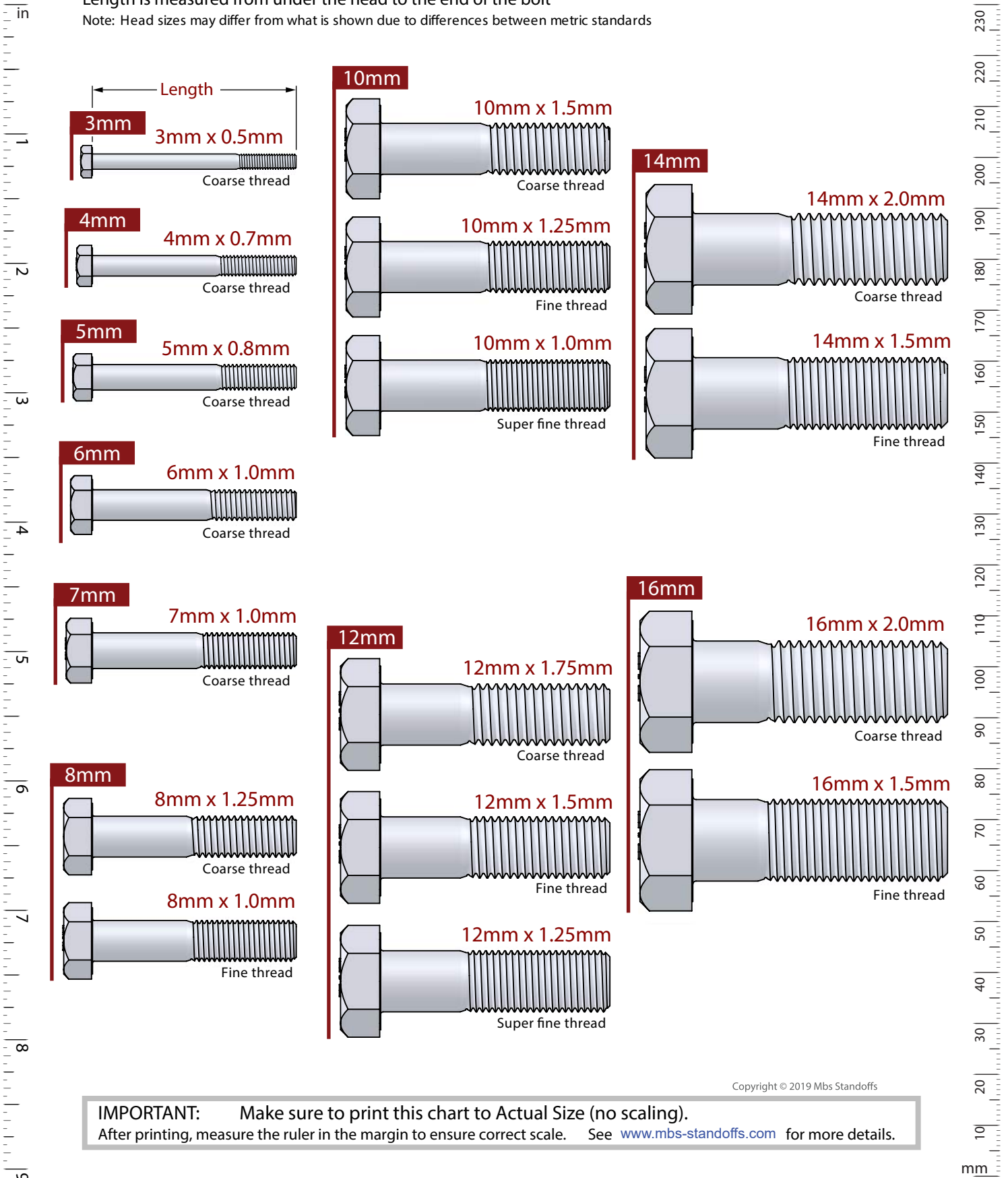

Copyright © 2019 Mbs Standoffs

IMPORTANT: Make sure to print this chart to Actual Size (no scaling).
After printing, measure the ruler in the margin to ensure correct scale. See www.mbs-standoffs.com for more details.

Standard Metric Machine Screw Sizes

Length is measured from where the surface is assumed to be, to the end of the screw. Therefore, pan head screws are measured from under the head, and flat head screws are measured overall.

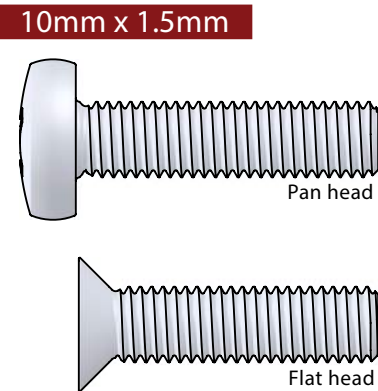
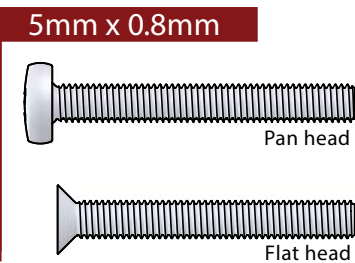
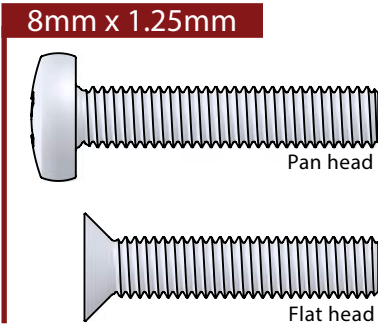
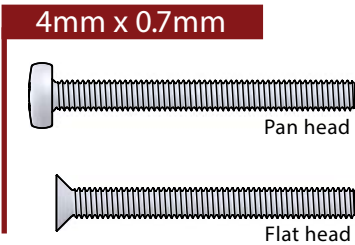
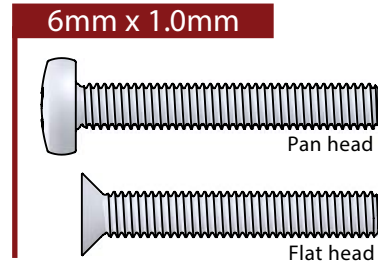
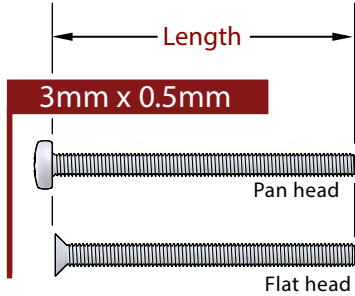
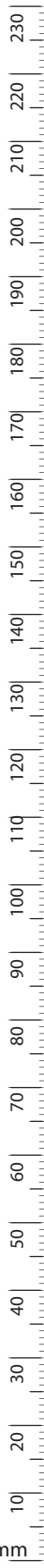

IMPORTANT: Make sure to print this chart to Actual Size (no scaling).
After printing, measure the ruler in the margin to ensure correct scale. See www.mbs-standoffs.com for more details.

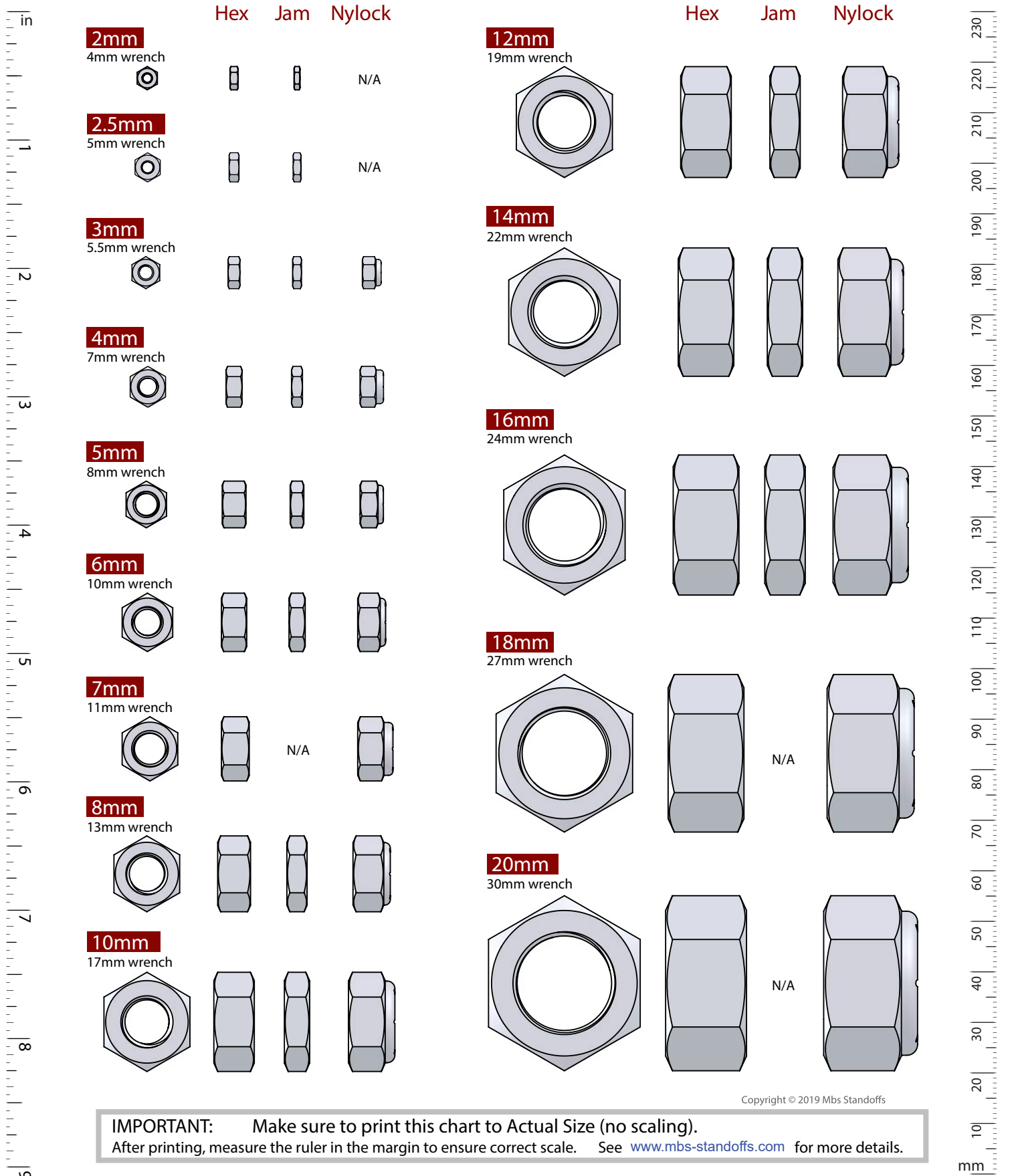

IMPORTANT: Make sure to print this chart to Actual Size (no scaling).
 After printing, measure the ruler in the margin to ensure correct scale. See www.mbs-standoffs.com for more details.



Metric Flat Washer Sizes

Washer sizes correspond to the screw/bolt diameter they fit. For example, an 8mm washer fits an 8mm bolt, and therefore has an inner diameter of just over 8mm.

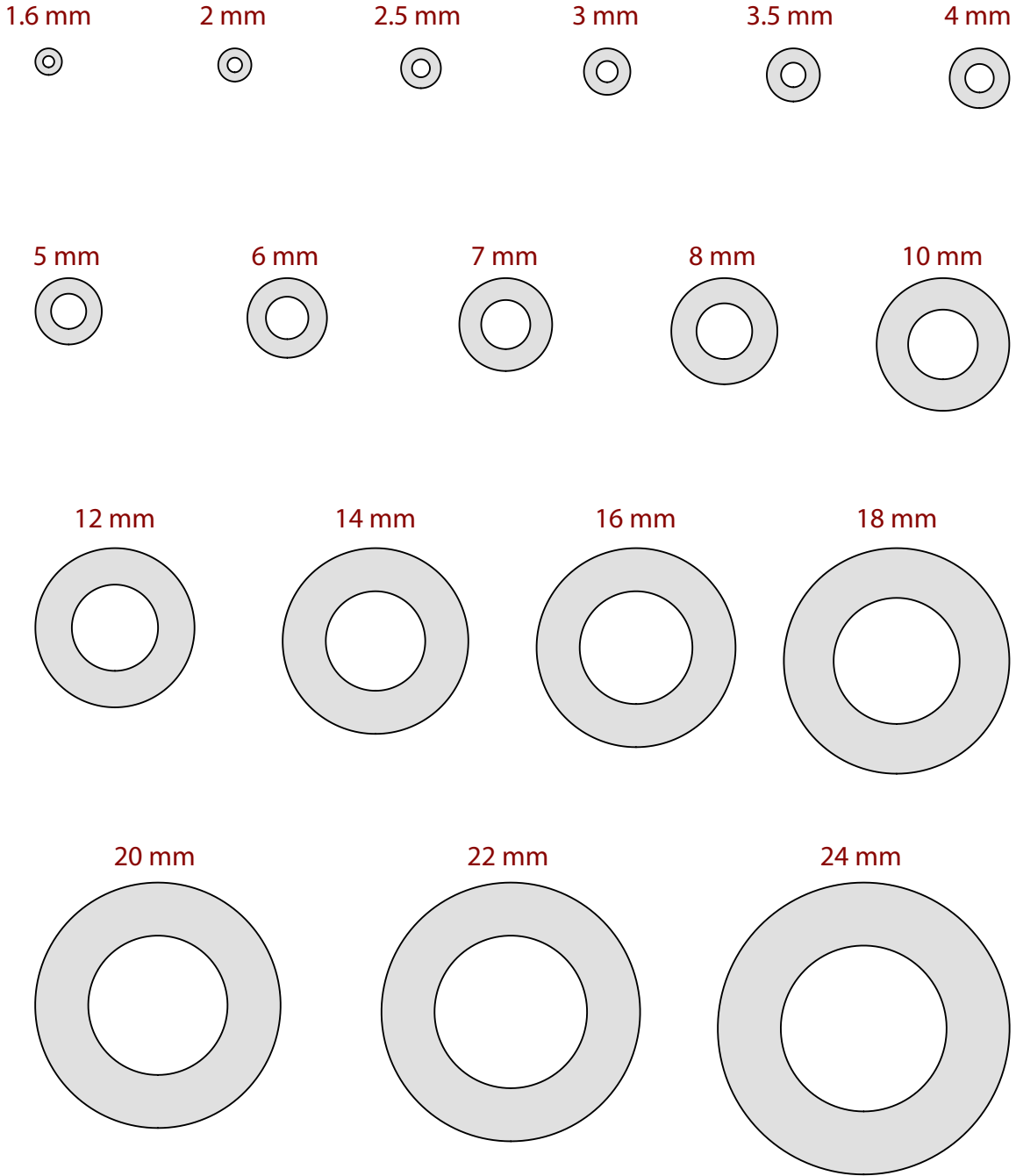
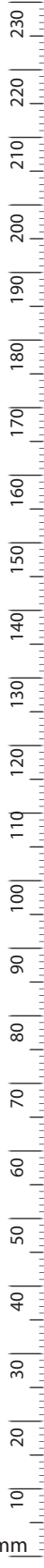
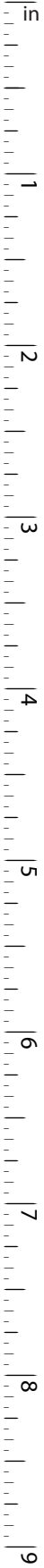

Copyright © 2019 Mbs Standoffs

IMPORTANT: Make sure to print this chart to Actual Size (no scaling).
After printing, measure the ruler in the margin to ensure correct scale. See www.mbs-standoffs.com for more details.

Metric Shoulder Bolt Sizes

www.mbs-standoffs.com

Shoulder bolt size is determined by the diameter and length of the shoulder.

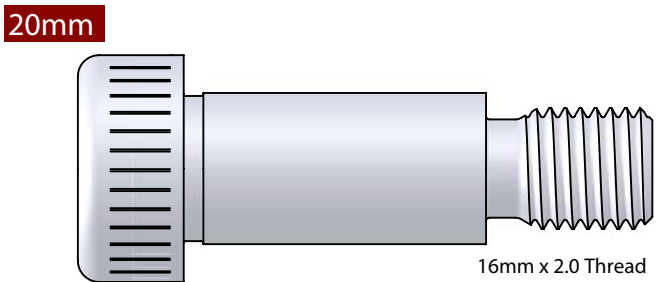
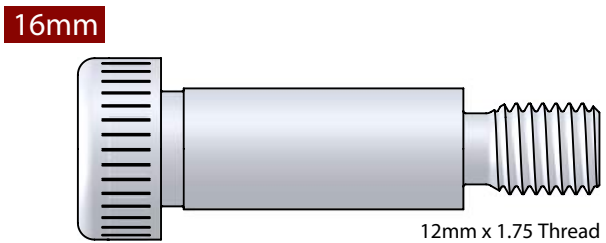
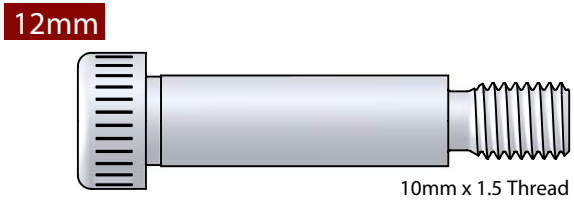
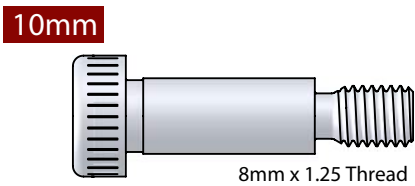
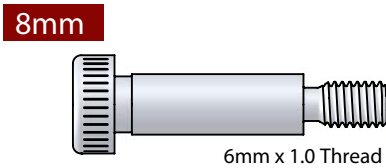
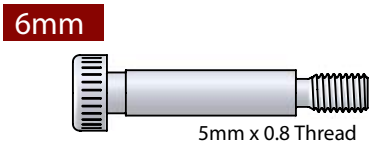
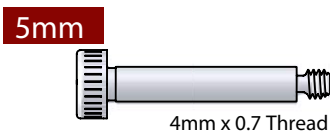
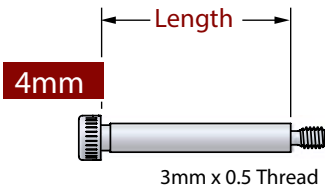

Copyright © 2019 Mbs Standoffs

IMPORTANT: Make sure to print this chart to Actual Size (no scaling).
After printing, measure the ruler in the margin to ensure correct scale. See www.mbs-standoffs.com for more details.

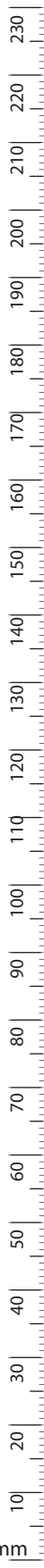
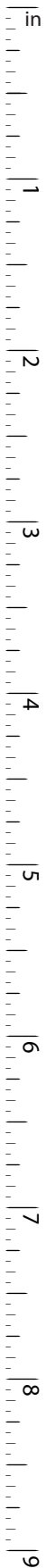

Metric Socket Cap Sizes

www.mbs-standoffs.com

Fastener length is measured from where the material surface is assumed to be, to the end of the fastener.

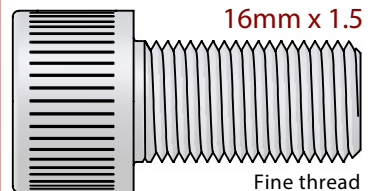
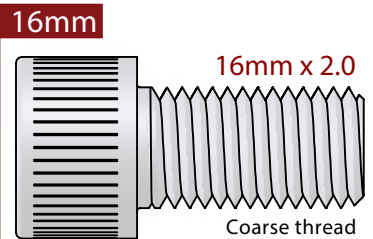
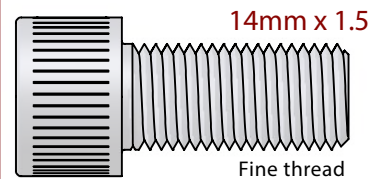
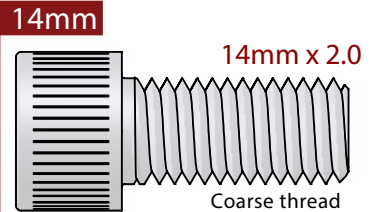
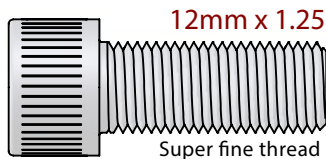
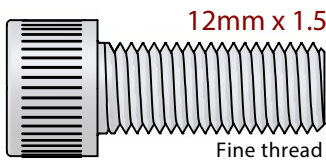
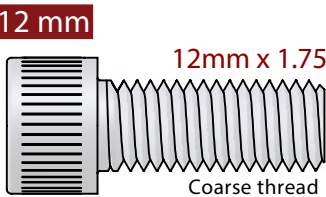
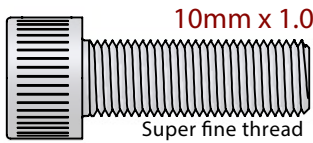
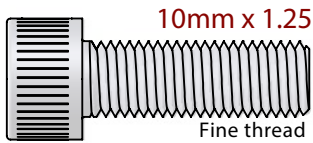
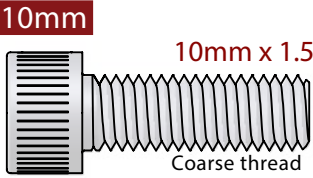
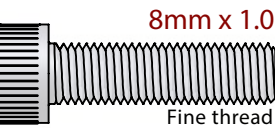
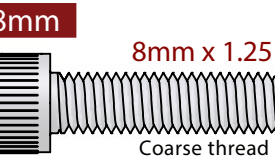
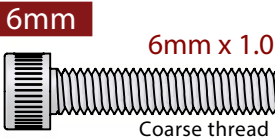
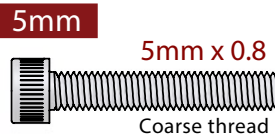
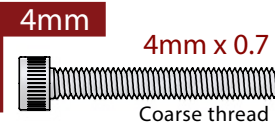
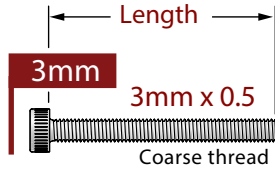
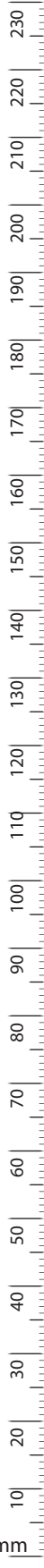
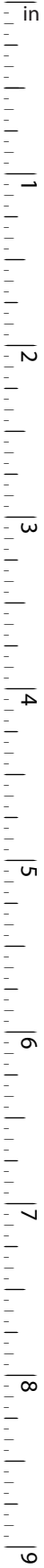

IMPORTANT: Make sure to print this chart to Actual Size (no scaling).
After printing, measure the ruler in the margin to ensure correct scale. See www.mbs-standoffs.com for more details.

Copyright © 2019 Mbs Standoffs

mm

Metric Socket Flat Head Sizes

Fastener length is measured from where the material surface is assumed to be, to the end of the fastener.

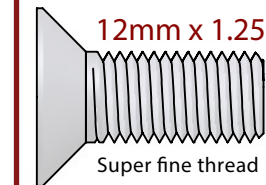
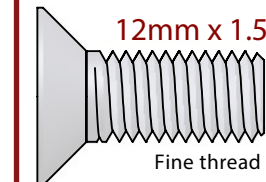
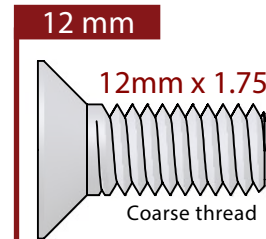
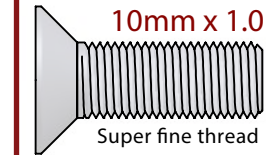
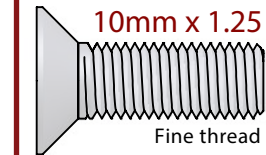
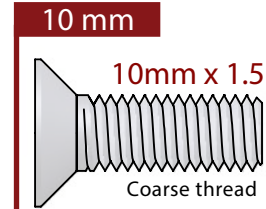
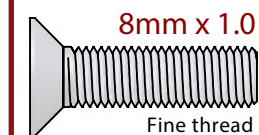
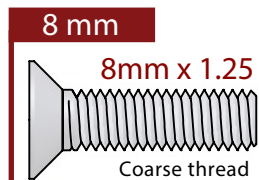
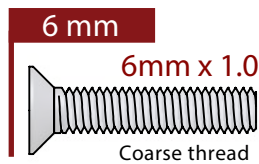
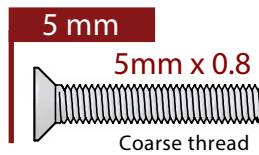
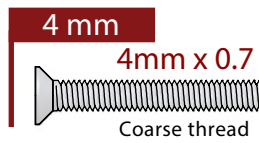
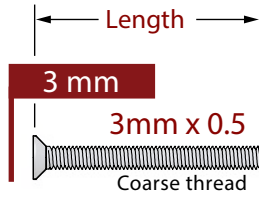

IMPORTANT: Make sure to print this chart to Actual Size (no scaling).
After printing, measure the ruler in the margin to ensure correct scale. See www.mbs-standoffs.com for more details.

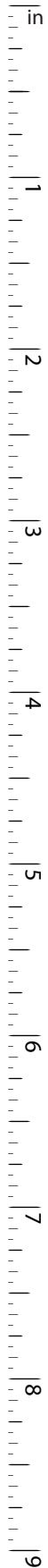

Metric Socket Button Head Sizes

www.mbs-standoffs.com

Fastener length is measured from where the material surface is assumed to be, to the end of the fastener.

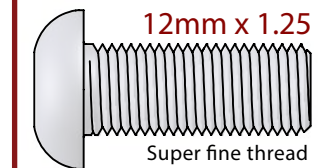
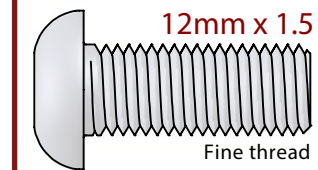
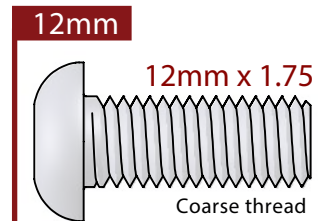
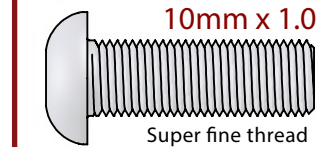
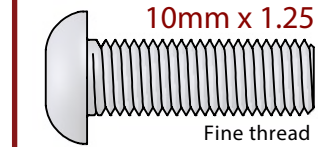
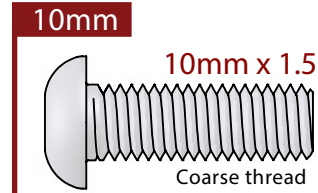
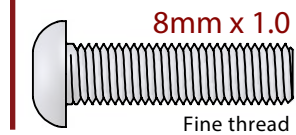
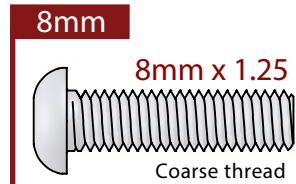
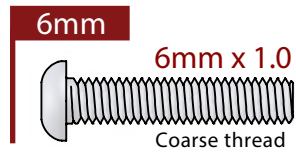
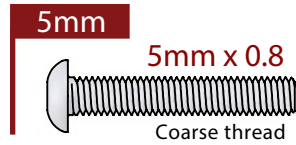
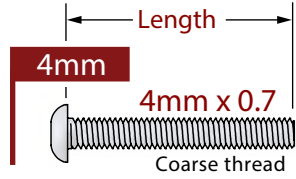
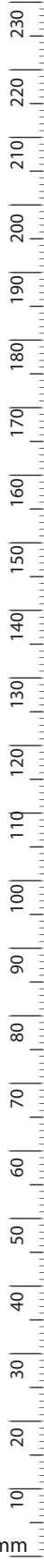
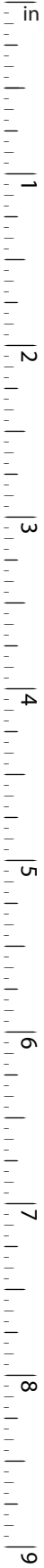

Copyright © 2019 Mbs Standoffs

IMPORTANT: Make sure to print this chart to Actual Size (no scaling).
After printing, measure the ruler in the margin to ensure correct scale. See www.mbs-standoffs.com for more details.